

# OPERATING INSTRUCTIONS

EN

Translation of the Original

## TC 80

Electronic drive unit

---

## Dear Customer,

Thank you for choosing a Pfeiffer Vacuum product. Your new turbopump is designed to support you by its performance, its perfect operation and without interfering your individual application. The name Pfeiffer Vacuum stands for high-quality vacuum technology, a comprehensive and complete range of top-quality products and first-class service. With this expertise, we have acquired a multitude of skills contributing to an efficient and secure implementation of our product.

Knowing that our product must not interfere with your actual work, we are convinced that our product offers you the solution that supports you in the effective and trouble-free execution of your individual application.

Please read these operating instructions before putting your product into operation for the first time. If you have any questions or suggestions, please feel free to contact [info@pfeiffer-vacuum.de](mailto:info@pfeiffer-vacuum.de).

Further operating instructions from Pfeiffer Vacuum can be found in the [Download Center](#) on our website.

## Disclaimer of liability

These operating instructions describe all models and variants of your product. Note that your product may not be equipped with all features described in this document. Pfeiffer Vacuum constantly adapts its products to the latest state of the art without prior notice. Please take into account that online operating instructions can deviate from the printed operating instructions supplied with your product.

Furthermore, Pfeiffer Vacuum assumes no responsibility or liability for damage resulting from the use of the product that contradicts its proper use or is explicitly defined as foreseeable misuse.

## Copyright

This document is the intellectual property of Pfeiffer Vacuum and all contents of this document are protected by copyright. They may not be copied, altered, reproduced or published without the prior written permission of Pfeiffer Vacuum.

We reserve the right to make changes to the technical data and information in this document.

# Table of contents

<b>1</b>	<b>About this manual</b>	<b>7</b>
1.1	Validity	7
1.2	Applicable documents	7
1.3	Target group	7
1.4	Conventions	7
	1.4.1 Instructions in the text	7
	1.4.2 Pictographs	7
	1.4.3 Stickers on the product	8
	1.4.4 Abbreviations	8
<b>2</b>	<b>Safety</b>	<b>10</b>
2.1	General safety information	10
2.2	Safety instructions	10
2.3	Safety precautions	12
2.4	Limits of use of the product	12
2.5	Proper use	13
2.6	Foreseeable improper use	13
<b>3</b>	<b>Product description</b>	<b>14</b>
3.1	Identifying the product	14
3.2	Product features	14
3.3	Function	14
3.4	Scope of delivery	14
3.5	Connectors	15
<b>4</b>	<b>Installation</b>	<b>16</b>
4.1	Connection diagram	16
4.2	"X3" connector	18
	4.2.1 Voltage supply	19
	4.2.2 Inputs	19
	4.2.3 Outputs	20
	4.2.4 RS-485	20
<b>5</b>	<b>Interfaces</b>	<b>21</b>
5.1	Interface RS-485	21
	5.1.1 Connection options	21
	5.1.2 Cross-linked via the RS-485 connection	22
5.2	Pfeiffer Vacuum protocol for RS-485 interface	22
	5.2.1 Telegram frame	22
	5.2.2 Telegram description	23
	5.2.3 Telegram example 1	23
	5.2.4 Telegram example 2	23
	5.2.5 Data types	24
<b>6</b>	<b>Parameter set</b>	<b>25</b>
6.1	General	25
6.2	Control commands	25
6.3	Status requests	28
6.4	Reference value inputs	29
6.5	Additional parameters for the control unit	30
<b>7</b>	<b>Operation</b>	<b>32</b>
7.1	Configuring the connections with the Pfeiffer Vacuum parameter set	32
	7.1.1 Configure digital inputs	32
	7.1.2 Configuring the digital outputs	32
	7.1.3 Configure analog output	33
	7.1.4 Configure accessory connections	33

7.1.5	Select interfaces	34
7.2	Operating modes	34
7.2.1	Gas type-dependent operation	34
7.2.2	Set value power consumption	35
7.2.3	Run-up time	35
7.2.4	Rotation speed switch points	35
7.2.5	Rotation speed setting mode	36
7.2.6	Standby	37
7.2.7	Confirming the speed specification	37
7.2.8	Backing pump operating modes	37
7.2.9	Backing pump standby mode	38
7.2.10	Operation with accessories	39
7.2.11	Venting modes	39
7.3	Switching on the turbopump	40
7.4	Switching off the turbopump	40
7.5	Operation monitoring	40
7.5.1	Operating mode display via LED	40
7.5.2	Temperature monitoring	41
<b>8</b>	<b>Recycling and disposal</b>	<b>42</b>
8.1	General disposal information	42
8.2	Dispose of electronic drive unit	42
<b>9</b>	<b>Malfunctions</b>	<b>43</b>
9.1	General	43
9.2	Error codes	43
9.3	Warning and malfunction messages when operating with control units	46
<b>10</b>	<b>Service solutions by Pfeiffer Vacuum</b>	<b>47</b>
	<b>EU Declaration of conformity</b>	<b>49</b>
	<b>UK Declaration of Conformity</b>	<b>50</b>

## List of tables

Tbl. 1:	Stickers on the product	8
Tbl. 2:	Abbreviations used in this document	9
Tbl. 3:	Permissible ambient conditions	13
Tbl. 4:	Features of the device variants	14
Tbl. 5:	Connection description of the electronic drive unit	15
Tbl. 6:	Terminal layout of the 15-pin connection "X3"	19
Tbl. 7:	Features of the RS-485 interface	21
Tbl. 8:	Explanation and meaning of the parameters	25
Tbl. 9:	Control commands	28
Tbl. 10:	Status requests	29
Tbl. 11:	Reference value inputs	30
Tbl. 12:	Parameters for control unit functions	31
Tbl. 13:	Configure parameters [P:062] and [P:063]	32
Tbl. 14:	Configure parameters [P:019] and [P:024]	33
Tbl. 15:	Configure parameter [P:055]	33
Tbl. 16:	Configure accessory connections	33
Tbl. 17:	Parameter [P:060]	34
Tbl. 18:	Parameter [P:061]	34
Tbl. 19:	Characteristic nominal rotation speeds of the turbopumps	37
Tbl. 20:	Backing pump operating modes	37
Tbl. 21:	Behavior and meaning of the LEDs on the electronic drive unit	41
Tbl. 22:	Error messages of the electronic drive unit	45
Tbl. 23:	Warning messages of the electronic drive unit	46
Tbl. 24:	Warning and malfunction messages	46

## List of figures

Fig. 1:	Position of the sticker on the product	8
Fig. 2:	Connection TC 80 and LED operating mode display	14
Fig. 3:	Connection diagram for TC 80 with connection cable	17
Fig. 4:	Connection diagram for TC 80 with connection cable and accessories	17
Fig. 5:	Connection diagram for TC 80 with external wiring	18
Fig. 6:	Connection of the electronic drive unit via "X3"	21
Fig. 7:	Cross-link via connection "X3" using connection cables	22
Fig. 8:	Schematic diagram of power characteristics, example of heavy gases [P:027] = 0	34
Fig. 9:	Rotation speed switch point 1 active	35
Fig. 10:	Rotation speed switch points 1 & 2 active, [P:701] > [P:719]	36
Fig. 11:	Rotation speed switch points 1 & 2 active, [P:701] < [P:719]	36

# 1 About this manual



## IMPORTANT

Read carefully before use.  
Keep the manual for future consultation.

## 1.1 Validity

These operating instructions are a customer document of Pfeiffer Vacuum. The operating instructions describe the functions of the named product and provide the most important information for the safe use of the device. The description is written in accordance with the valid directives. The information in these operating instructions refers to the product's current development status. The document shall remain valid provided that the customer does not make any changes to the product.

## 1.2 Applicable documents

TC 80	Operating instructions
Declaration of conformity	A component of these instructions

## 1.3 Target group

These operating instructions are aimed at all persons performing the following activities on the product:

- Transportation
- Setup (Installation)
- Usage and operation
- Decommissioning
- Maintenance and cleaning
- Storage or disposal

The work described in this document is only permitted to be performed by persons with the appropriate technical qualifications (expert personnel) or who have received the relevant training from Pfeiffer Vacuum.

## 1.4 Conventions

### 1.4.1 Instructions in the text

Usage instructions in the document follow a general structure that is complete in itself. The required action is indicated by an individual step or multi-part action steps.

#### Individual action step

A horizontal, solid triangle indicates the only step in an action.

- ▶ This is an individual action step.

#### Sequence of multi-part action steps

The numerical list indicates an action with multiple necessary steps.

1. Step 1
2. Step 2
3. ...

### 1.4.2 Pictographs

Pictographs used in the document indicate useful information.



Note



Tip

### 1.4.3 Stickers on the product

This section describes all the stickers on the product along with their meanings.

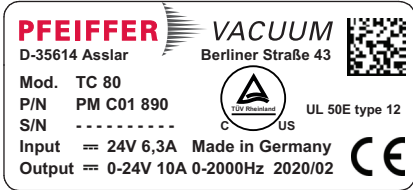
 <p><b>PFEIFFER</b> <b>VACUUM</b>          D-35614 Asslar Berliner Straße 43          Mod. TC 80          P/N PM C01 890          S/N -----          Input == 24V 6,3A Made in Germany          Output == 0-24V 10A 0-2000Hz 2020/02</p> <p>UL 50E type 12          CE</p>	<p><b>Rating plate</b>          The rating plate is located on the bottom side of the electronic drive unit.</p>
---	--

Tbl. 1: Stickers on the product

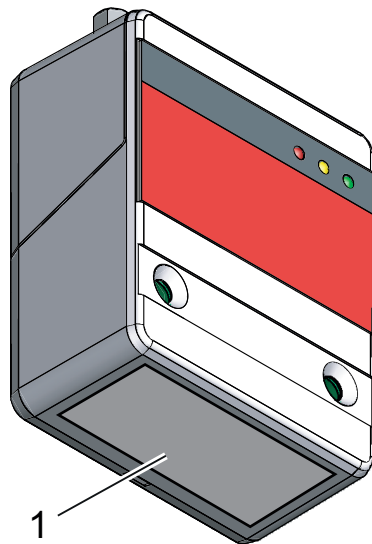

Fig. 1: Position of the sticker on the product

1 Rating plate

### 1.4.4 Abbreviations

Abbreviation	Meaning in this document
AI/AO	Analog input/analog output
AIC	Ampere interrupting capacity
DC	Direct current
DI/DO	Digital input/digital output
f	Rotation speed value of a vacuum pump (frequency, in rpm or Hz)
I	Electric amperage
LED	Light emitting diode
[P:xxx]	Electronic drive unit control parameters. Printed in bold as a three-digit number in square brackets. Frequently displayed in conjunction with a short description Example: <b>[P:312]</b> software version
P	Electrical power
PE	Protective ground (earth)
R	Electrical resistance



<b>Abbreviation</b>	<b>Meaning in this document</b>
<b>RS-485</b>	Standard for a physical interface for asynchronous serial data transmission (Recommended Standard)
<b>t</b>	Time
<b>TC</b>	Turbopump electronic drive unit (turbo controller)
<b>TMS</b>	Temperature management system
<b>U</b>	Electric voltage
<b>X3</b>	15-pole D-Sub connecting socket on the electronic drive unit

**Tbl. 2: Abbreviations used in this document**

## 2 Safety

### 2.1 General safety information

The following 4 risk levels and 1 information level are taken into account in this document.

<b>⚠ DANGER</b>	
<p><b>Immediately pending danger</b>                  Indicates an immediately pending danger that will result in death or serious injury if not observed.</p> <ul style="list-style-type: none"> <li>▶ Instructions to avoid the danger situation</li> </ul>	
<b>⚠ WARNING</b>	
<p><b>Potential pending danger</b>                  Indicates a pending danger that could result in death or serious injury if not observed.</p> <ul style="list-style-type: none"> <li>▶ Instructions to avoid the danger situation</li> </ul>	
<b>⚠ CAUTION</b>	
<p><b>Potential pending danger</b>                  Indicates a pending danger that could result in minor injuries if not observed.</p> <ul style="list-style-type: none"> <li>▶ Instructions to avoid the danger situation</li> </ul>	
<b>NOTICE</b>	
<p><b>Danger of damage to property</b>                  Is used to highlight actions that are not associated with personal injury.</p> <ul style="list-style-type: none"> <li>▶ Instructions to avoid damage to property</li> </ul>	
<div style="border: 1px solid black; padding: 5px; display: inline-block;">  </div>	Notes, tips or examples indicate important information about the product or about this document.

### 2.2 Safety instructions

All safety instructions in this document are based on the results of the risk assessment carried out in accordance with Low Voltage Directive 2014/35/EU. Where applicable, all life cycle phases of the product were taken into account.

#### Risks during installation

<b>⚠ DANGER</b>
<p><b>Danger to life from electric shock</b>                  Power supply packs that are not specified or are not approved will lead to severe injury to death.</p> <ul style="list-style-type: none"> <li>▶ Make sure that the power supply pack meets the requirements for double isolation between mains input voltage and output voltage, in accordance with IEC 61010-1 IEC 60950-1 and IEC 62368-1.</li> <li>▶ Make sure that the power supply pack meets the requirements in accordance with IEC 61010-1 IEC 60950-1 and IEC 62368-1.</li> <li>▶ Where possible, use original power supply packs or only power supply packs that correspond with the applicable safety regulations.</li> </ul>

**⚠ DANGER****Danger to life from electric shock**

When establishing the voltages that exceed the specified safety extra-low voltage (according to IEC 60449 and VDE 0100), the insulating measures will be destroyed. There is a danger to life from electric shock at the communication interfaces.

- ▶ Connect only suitable devices to the bus system.

**⚠ WARNING****Risk of danger to life through missing mains disconnection device**

The vacuum pump and electronic drive unit are **not** equipped with a mains disconnection device (mains switch).

- ▶ Install a mains disconnection device according to SEMI-S2.
- ▶ Install a circuit breaker with an interruption rating of at least 10,000 A.

**⚠ WARNING****Risk of injury due to incorrect installation**

Dangerous situations may arise from unsafe or incorrect installation.

- ▶ Do not carry out your own conversions or modifications on the unit.
- ▶ Ensure the integration into an Emergency Off safety circuit.

**Risks in the event of malfunctions****⚠ WARNING****Risk of injury from parts moving after a power failure or troubleshooting**

The "pumping station" function of the electronic drive unit will remain active after a power failure or if errors occur that shut down the vacuum pump or the system. When power is restored or after acknowledging a fault, the vacuum pump runs up automatically. There is a risk of injury to fingers and hands if they enter the operating range of rotating parts.

- ▶ Always keep the mains connection freely accessible so you can disconnect it at any time.
- ▶ Remove present mating plugs or bridges from the electronic drive unit possibly before the mains power returns, as these can cause an automatic run-up.
- ▶ Switch the pump off using the "Pumping station" function (parameter **[P:010]**).

**⚠ WARNING****Danger to life from electric shock during maintenance and service work**

The device is only completely de-energized when the mains plug has been disconnected and the vacuum pump is at a standstill. There is a danger to life from electric shock when making contact with live components.

- ▶ Before performing all work, switch off the main switch.
- ▶ Wait until the vacuum pump comes to a standstill (rotation speed =0).
- ▶ Disconnect all connection cables.
- ▶ Remove the mains plug from the device.
- ▶ Secure the device against unintentional restarting.

Risks during disposal

**⚠ WARNING**

**Health hazard through poisoning from toxic contaminated components or devices**

Toxic process media result in contamination of devices or parts of them. During maintenance work, there is a risk to health from contact with these poisonous substances. Illegal disposal of toxic substances causes environmental damage.

- ▶ Take suitable safety precautions and prevent health hazards or environmental pollution by toxic process media.
- ▶ Decontaminate affected parts before carrying out maintenance work.
- ▶ Wear protective equipment.

### 2.3 Safety precautions

**i** **Duty to provide information on potential dangers**

The product holder or user is obliged to make all operating personnel aware of dangers posed by this product.

Every person who is involved in the installation, operation or maintenance of the product must read, understand and adhere to the safety-related parts of this document.

**i** **Infringement of conformity due to modifications to the product**

The Declaration of Conformity from the manufacturer is no longer valid if the operator changes the original product or installs additional equipment.

- Following the installation into a system, the operator is required to check and re-evaluate the conformity of the overall system in the context of the relevant European Directives, before commissioning that system.

**General safety precautions when handling the product**

- ▶ Use only power supply packs that comply with the applicable safety regulations.
- ▶ Observe all applicable safety and accident prevention regulations.
- ▶ Check that all safety measures are observed at regular intervals.
- ▶ Recommendation: Establish a secure connection to the earthed conductor (PE); protection class III.
- ▶ Never disconnect plug connections during operation.
- ▶ Keep lines and cables away from hot surfaces (> 70 °C).
- ▶ Do not carry out your own conversions or modifications on the unit.
- ▶ Observe the unit protection class prior to installation or operation in other environments.
- ▶ Observe the protection class by ensuring the correct seating of the present sealing plugs.
- ▶ Disconnect the electronic drive unit only once everything has come to a complete standstill and when the mains power supply of the turbopump is interrupted.

### 2.4 Limits of use of the product

Installation location	weatherproof (internal space)
Air pressure	750 hPa to 1060 hPa
Installation altitude	max. 5000 m
Rel. air humidity	up to max. 100%
Protection class (according to IEC 61010)	III
Degree of pollution (according to IEC 61010)	2
Overvoltage category	II

Permissible protection degree	IP54 Type 12 according to UL 50E
Ambient temperature	+5 °C to +50 °C

**Tbl. 3: Permissible ambient conditions**



**Notes on ambient conditions**

The specified permissible ambient temperatures apply to operation of the turbopump at maximum permissible backing pressure or at maximum gas throughput, depending on the cooling type. The turbopump is intrinsically safe thanks to redundant temperature monitoring.

- The reduction in backing pressure or gas throughput permits operation of the turbopump at higher ambient temperatures.
- If the maximum permissible operating temperature of the turbopump is exceeded, the electronic drive unit first reduces the drive output and then switches it off where necessary.

## 2.5 Proper use

- The electronic drive unit is used exclusively for the operation of Pfeiffer Vacuum turbopumps and their accessories.

## 2.6 Foreseeable improper use

Improper use of the product invalidates all warranty and liability claims. Any use that is counter to the purpose of the product, whether intentional or unintentional, is regarded as misuse, in particular:

- Connection to power supplies that do not comply with the provisions of IEC 61010 or IEC 60950
- Operation with excessively high irradiated heat output
- Use in areas with ionizing radiation
- Operation in explosion-hazard areas
- Use of accessories or spare parts that are not listed in these instructions

## 3 Product description

### 3.1 Identifying the product

- ▶ To ensure clear identification of the product when communicating with Pfeiffer Vacuum, always keep all of the information on the rating plate to hand.
- ▶ Learn about certifications through test seals on the product or at [www.certipedia.com](http://www.certipedia.com) with company ID no. [000021320](https://www.certipedia.com/entry/000021320).

### 3.2 Product features

The type TC 80 electronic drive unit is a permanent component of the turbopump. The purpose of the electronic drive unit is to drive, monitor and control the entire turbopump.

Feature	TC 80
Connection voltage TC	24 V DC $\pm$ 10%
Connection panel	Standard (X3)
Turbopump	HiPace 10 Neo HiPace 30 Neo HiPace 80 Neo

Tbl. 4: Features of the device variants

### 3.3 Function

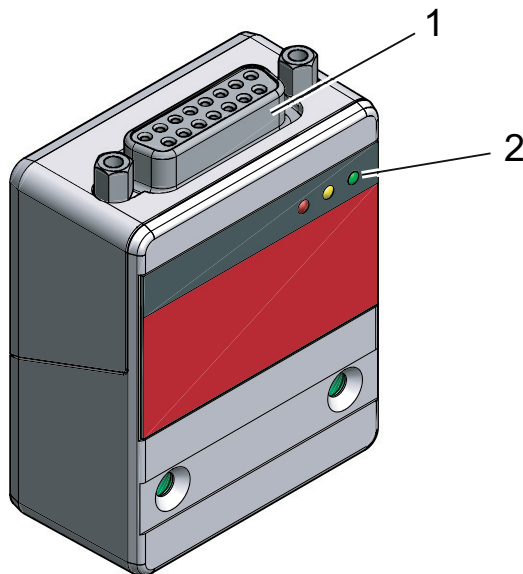



Fig. 2: Connection TC 80 and LED operating mode display

- 1 Multifunction connection "X3"      2 LED operating mode display

### 3.4 Scope of delivery

- TC 80 as integrated part of turbopump
- Operating instructions

### 3.5 Connectors

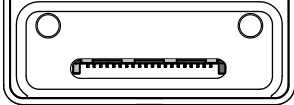
	<b>X3</b> 15-pin D-Sub socket for connecting and configuring a remote control and for Pfeiffer Vacuum service tasks.
	Device socket on the rear side of the electronic drive unit for connecting the turbopump.

**Tbl. 5:** Connection description of the electronic drive unit

## 4 Installation

### 4.1 Connection diagram

#### **DANGER**

##### **Danger to life from electric shock**

Power supply packs that are not specified or are not approved will lead to severe injury to death.

- ▶ Make sure that the power supply pack meets the requirements for double isolation between mains input voltage and output voltage, in accordance with IEC 61010-1 IEC 60950-1 and IEC 62368-1.
- ▶ Make sure that the power supply pack meets the requirements in accordance with IEC 61010-1 IEC 60950-1 and IEC 62368-1.
- ▶ Where possible, use original power supply packs or only power supply packs that correspond with the applicable safety regulations.

#### **DANGER**

##### **Danger to life from electric shock**

When establishing the voltages that exceed the specified safety extra-low voltage (according to IEC 60449 and VDE 0100), the insulating measures will be destroyed. There is a danger to life from electric shock at the communication interfaces.

- ▶ Connect only suitable devices to the bus system.

#### **WARNING**

##### **Risk of danger to life through missing mains disconnection device**

The vacuum pump and electronic drive unit are **not** equipped with a mains disconnection device (mains switch).

- ▶ Install a mains disconnection device according to SEMI-S2.
- ▶ Install a circuit breaker with an interruption rating of at least 10,000 A.

#### **WARNING**

##### **Risk of injury due to incorrect installation**

Dangerous situations may arise from unsafe or incorrect installation.

- ▶ Do not carry out your own conversions or modifications on the unit.
- ▶ Ensure the integration into an Emergency Off safety circuit.



##### **Contact loads at X3**

1. Note the maximum contact load of 6 mA per logic input.
2. Note the maximum contact load of 50 mA per logic output.
3. Note the maximum contact load of 700 mA at the accessory outputs.
4. Do not exceed the total sum of the load of all connections of 700 mA.



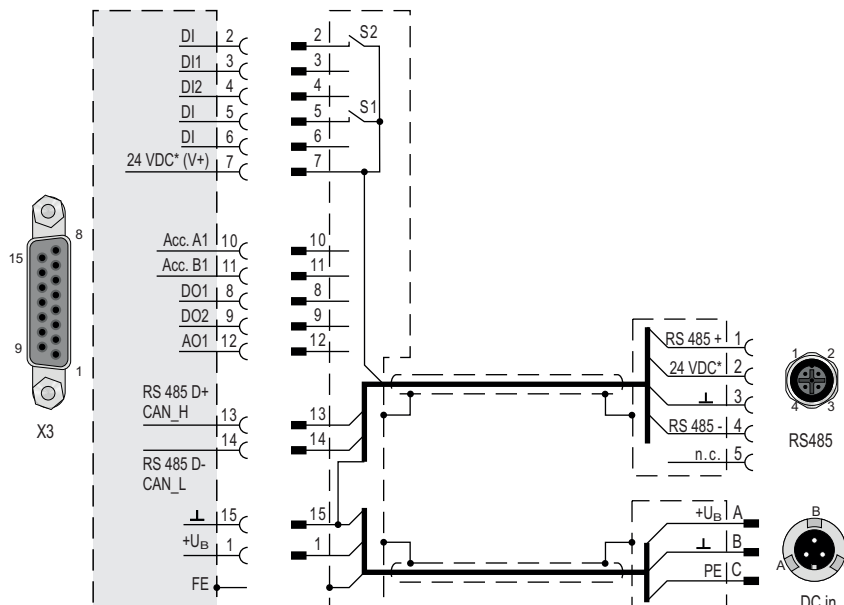

Fig. 3: Connection diagram for TC 80 with connection cable

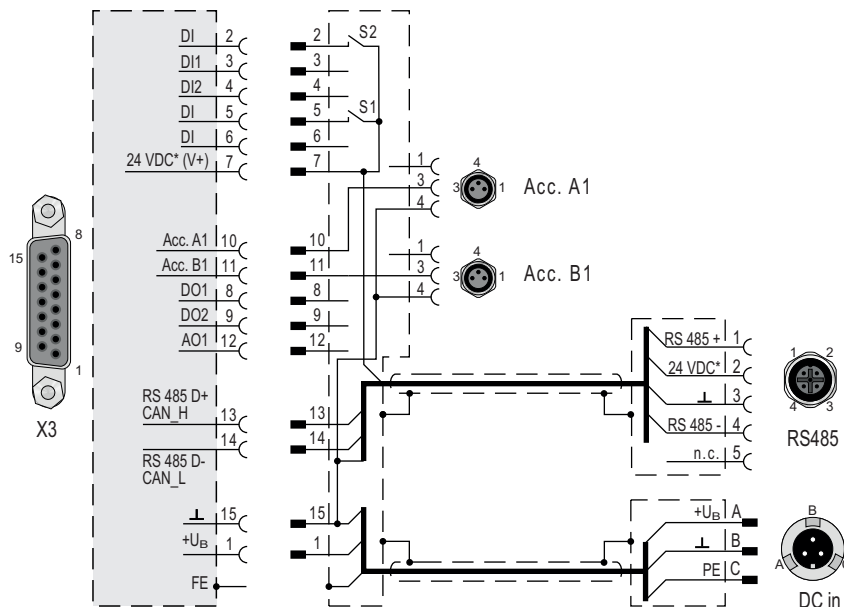

Fig. 4: Connection diagram for TC 80 with connection cable and accessories

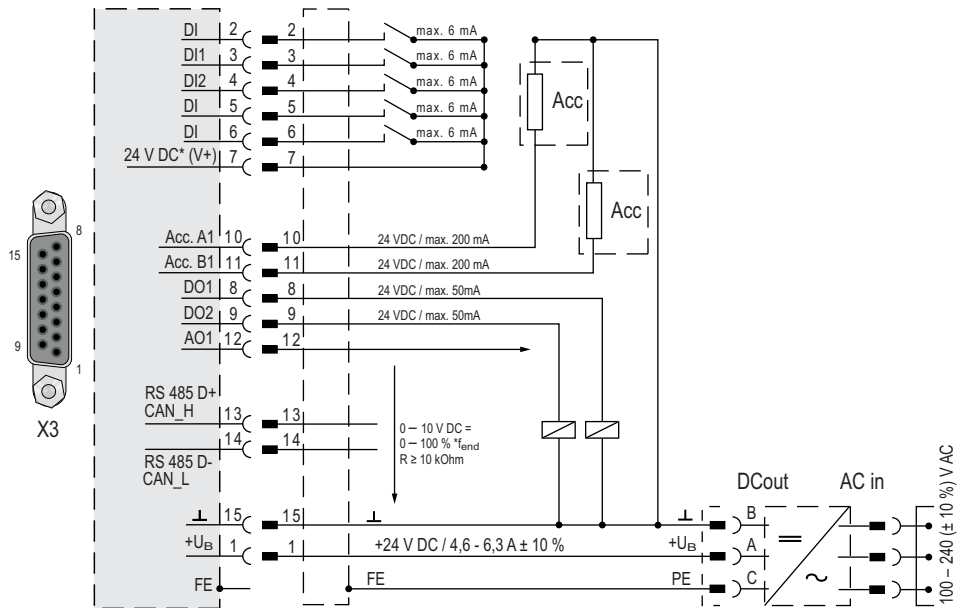

Fig. 5: Connection diagram for TC 80 with external wiring

## 4.2 "X3" connector

### NOTICE

#### Property damage on the electronics

Separating the "X3" plug-and-socket connection with voltage supply switched on may lead to the destruction of electronic components.

- ▶ Always interrupt the voltage supply before disconnecting the "X3" connecting plug.
- ▶ Switch off the power supply pack.
- ▶ After switching off the power supply pack, wait until the residual load has dispersed completely before disconnecting the plug-and-socket connection.

The 15-pin sub-D connection with the "X3" designation offers the possibility to operate the electronic drive unit remotely. The following specifications are the factory settings for the electronic drive unit. They can be configured with the Pfeiffer Vacuum parameter set.

- ▶ Utilize the screened plug and cable.

Pin	Assignment	Description, factory setting
1	+24 V DC input	Voltage supply for the electronic drive unit
2	DI remote priority	Operation via "X3" interface (open: off; V+: set and takes priority over other digital inputs)
3	DI1	Enable venting (open: off, V+: on)
4	DI2	Heater (open: off, V+: on)
5	DI Pumping station	open: off; V+: on and malfunction acknowledgment
6	DI Standby DI malfunction acknowledgment	Standby rotation speed (open: off, V+: on) Malfunction acknowledgement: V+ pulse (500 - 2000 ms)
7	+24 V DC* output (V+)	Reference voltage for all digital inputs
8	DO1	GND: no, V+: yes ( $I_{max} = 50 \text{ mA}/24 \text{ V}$ )
9	DO2	GND: no, V+: yes ( $I_{max} = 50 \text{ mA}/24 \text{ V}$ )
10	Accessory output A1	open: off; V+: on
11	Accessory output B1	open: off; V+: on
12	AO1	Actual speed; 0 to 10 V DC corresponds to 0 to 100%: $R_L > 10 \text{ k}\Omega$
13	RS-485 CAN_H	D+
14	RS-485 CAN_L	D-
15	Ground (GND)	Ground connection of the voltage supply; reference ground for all digital inputs and outputs

Tbl. 6: Terminal layout of the 15-pin connection "X3"

## 4.2.1 Voltage supply

### +24 V DC input/pin 1

The electrical connection to "X3" is made using connection cable from the Pfeiffer Vacuum accessory program or, by the customer, at pin 1 and pin 15.

### +24 V DC\* output/pin 7

A connection with +24 V DC to pin 7 (active high) activates inputs 2 to 6. Alternatively, they can be activated via an external PLC. "PLC High level" activates and "PLC Low level" deactivates the functions.

- PLC High level: +13 V to +33 V
- PLC Low level: -33 V to +7 V
- $R_i$ : 7 k $\Omega$
- $I_{max} < 200 \text{ mA}$  (with RS-485, where present)

## 4.2.2 Inputs

The digital inputs at the "X3" connection are used to switch various electronic drive unit functions. Inputs DI1 to DI2 are assigned functions in the factory. You can configure them via the RS-485 interface and the Pfeiffer Vacuum parameter set.

### DI remote priority/pin 2

**V+:** Connection "X3" has an operating supremacy before all other digital inputs.

**open:** Remote priority inactive

### DI1 (release venting)/pin 3

**V+:** Enable venting (venting as per venting mode)

**open:** Venting blocked (no venting occurs)

### DI2 (heater)/pin 4

**V+:** Heater on

**open:** Heater off

**DI pumping station/pin 5**

Activation of the turbopump and control of connected pumping station components (e.g. backing pump, venting valve, air cooling). Any pending error messages are reset by eliminating the cause.

**V+:** Error acknowledgement and pumping station on

**open:** Pumping station off

**DI standby malfunction acknowledgment/pin 6**

In standby mode, the turbopump operates at a specified rotor speed < nominal rotation speed. The factory setting and recommended operation is 66.7 % of the nominal rotation speed.

**V+:** Standby activated

**V+:** Reset pending error messages when cause has been eliminated with a pulse of 500 to 2000 ms duration

**open:** Standby off, operation at nominal rotation speed

**4.2.3 Outputs**

The digital outputs at the "X3" connection have a maximum load limit of 24 V/50 mA per output. All outputs listed below are configurable with the Pfeiffer Vacuum parameter set via the RS-485 interface (description relates to factory settings).

**DO1 (rotation speed switch point reached)/pin 8**

Active high: After reaching the rotation speed switchpoint. Rotation speed switch point 1 has a factory setting of 80% of the nominal rotation speed. This can be used, for example, for a "Turbopump ready for operation" message.

**DO2 (no error)/pin 9**

When the supply voltage has been connected, digital output DO2 permanently outputs 24 V DC, which means "no error". Active low: in case of error (group error message).

**Accessory outputs/pin 10 and pin 11**

The accessory outputs have a maximum load limit of 24 V/200 mA. You can assign additional functions to the accessory inputs and outputs via control units or the PC.

**Factory setting**

- Accessory output A1: Control of connected air cooling.
- Accessory output B1: Control of a connected venting valve in accordance with venting release via input DI1.

**AO1 analog output 0 to 10 V DC/pin 12**

You can tap a speed-proportional voltage (0 to 10 V DC equals 0 to 100% ×  $f_{\text{nominal}}$ ) at the analog output (load  $R \geq 10 \text{ k}\Omega$ ). You can assign additional functions (optionally current/power) to the analog output via control units or a PC.

**4.2.4 RS-485****Connecting RS-485 via D-Sub**

- ▶ Connect a Pfeiffer Vacuum control unit or an external PC via pin 13 and pin 14 at the D-Sub connection of the electronic drive unit.

# 5 Interfaces

## 5.1 Interface RS-485

**⚠ DANGER**

**Danger to life from electric shock**

When establishing the voltages that exceed the specified safety extra-low voltage (according to IEC 60449 and VDE 0100), the insulating measures will be destroyed. There is a danger to life from electric shock at the communication interfaces.

► Connect only suitable devices to the bus system.

The interface designated “RS-485” is intended for connecting a Pfeiffer Vacuum control unit or an external PC. The connections are galvanically safe and are isolated from the maximum supply voltage for the electronic drive unit. The electrical connections are optically decoupled internally.

Designation	Value
Serial interface	RS-485
Baud rate	9600 Baud
Data word length	8 bit
Parity	none (no parity)
Start bits	1
Stop bits	1

Tbl. 7: Features of the RS-485 interface

### 5.1.1 Connection options

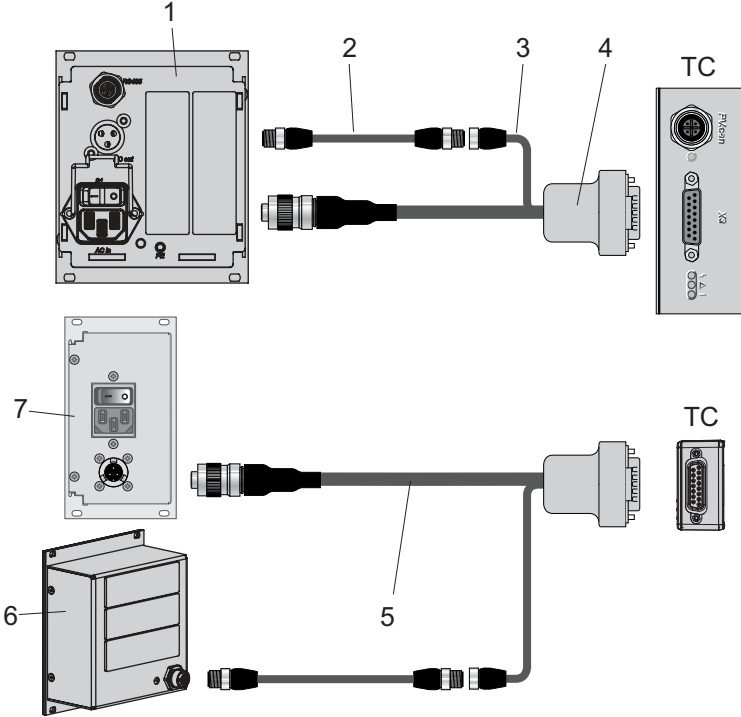

Fig. 6: Connection of the electronic drive unit via “X3”

- 1 Control unit with power supply pack
- 2 M12 to M12 extension cable
- 3 RS-485 interface connection
- 4 Connection cable
- 5 DCin connection
- 6 Control unit
- 7 Power supply pack

**Connecting control units**

- ▶ Use connection cables from the control unit scope of delivery or from the range of accessories.
- ▶ You can connect one external control unit to the RS-485 interface.
- ▶ You can connect a USB interface (PC) via the USB/RS-485 converter.

**5.1.2 Cross-linked via the RS-485 connection**

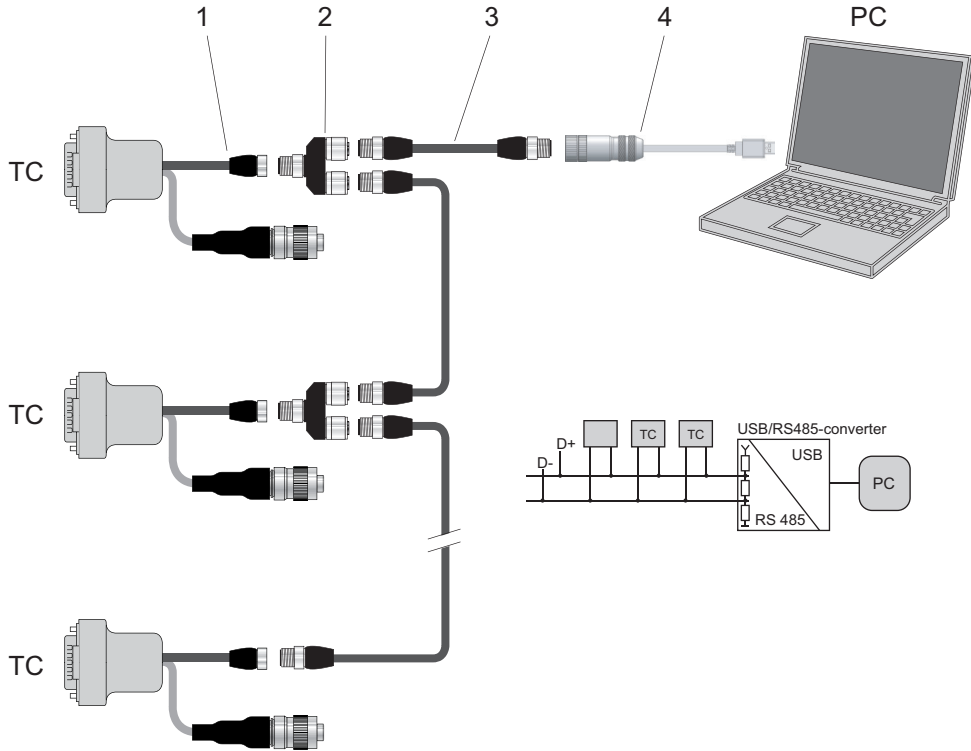

**Fig. 7: Cross-link via connection “X3” using connection cables**

- 1 Connection cable with RS-485
- 2 Y-connector for RS-485
- 3 M12 to M12 extension cable
- 4 USB RS-485 converter

**Networking as RS-485 bus**

The group address of the electronic drive unit is 967.

1. Install the devices according to the specification for RS-485 interfaces.
2. Make sure that all devices connected to the bus have different RS-485 device addresses [P:797].
3. Connect all devices with RS-485 D+ and RS-485 D- to the bus.

**5.2 Pfeiffer Vacuum protocol for RS-485 interface**

**5.2.1 Telegram frame**

The telegram frame of the Pfeiffer Vacuum protocol contains only ASCII code characters [32; 127], the exception being the end character of the telegram  $C_R$ . Basically, a host (e.g. a PC) sends a telegram, which a device (e.g. electronic drive unit or gauge) responds to.

a2	a1	a0	*	0	n2	n1	n0	l1	l0	dn	...	d0	c2	c1	c0	$C_R$
a2 – a0				Device address ○												
				<ul style="list-style-type: none"> <li>• Individual address of the unit ["001";"255"]</li> <li>• Group address "9xx" for all identical units (no response)</li> <li>• Global address "000" for all units on the bus (no response)</li> </ul>												
*				Action according to telegram description												
n2 – n0				Pfeiffer Vacuum parameter numbers												
l1 – l0				Data length dn to d0												

dn – d0	Data in the respective data type (see chapter "Data types", page 24).
c2 – c0	Checksum (sum of ASCII values of cells a2 to d0) modulo 256
C <sub>R</sub>	carriage return (ASCII 13)

### 5.2.2 Telegram description

**Data query**  --> 

a2	a1	a0	0	0	n2	n1	n0	0	2	=	?	c2	c1	c0	C <sub>R</sub>
----	----	----	---	---	----	----	----	---	---	---	---	----	----	----	----------------

**Control command**  --> 

a2	a1	a0	1	0	n2	n1	n0	l1	l0	dn	...	d0	c2	c1	c0	C <sub>R</sub>
----	----	----	---	---	----	----	----	----	----	----	-----	----	----	----	----	----------------

**Data response / Control command understood**  --> 

a2	a1	a0	1	0	n2	n1	n0	l1	l0	dn	...	d0	c2	c1	c0	C <sub>R</sub>
----	----	----	---	---	----	----	----	----	----	----	-----	----	----	----	----	----------------

**Error message**  --> 



a2	a1	a0	1	0	n2	n1	n0	0	6	N	O	_	D	E	F	c2	c1	c0	C <sub>R</sub>
										_	R	A	N	G	E				
										_	L	O	G	I	C				

- NO\_DEF            Parameter number n2–n0 no longer exists
- \_RANGE           Data dn–d0 outside the permissible range
- \_LOGIC           Logical access error

### 5.2.3 Telegram example 1



**Data query**

Current rotation speed (parameter [P:309], device address: "123")

 --> 	1	2	3	0	0	3	0	9	0	2	=	?	1	1	2	C <sub>R</sub>
ASCII	49	50	51	48	48	51	48	57	48	50	61	63	49	49	50	13

**Data response: 633 Hz**



Current rotation speed (parameter [P:309], device address: "123")

 --> 	1	2	3	1	0	3	0	9	0	6	0	0	0	6	3	3	0	3	7	C <sub>R</sub>
ASCII	49	50	51	49	48	51	48	57	48	54	48	48	48	54	51	51	48	51	55	13

### 5.2.4 Telegram example 2



**Control command**

Switch on the pumping station (parameter [P:010], device address: "042")

 --> 	0	4	2	1	0	0	1	0	0	6	1	1	1	1	1	1	0	2	0	C <sub>R</sub>
ASCII	48	52	50	49	48	48	49	48	48	54	49	49	49	49	49	49	48	50	48	13

**Control command understood**

Switch on the pumping station (parameter [P:010], device address: "042")

 --> 	0	4	2	1	0	0	1	0	0	6	1	1	1	1	1	1	0	2	0	C <sub>R</sub>
ASCII	48	52	50	49	48	48	49	48	48	54	49	49	49	49	49	49	48	50	48	13

## 5.2.5 Data types

No.	Data type	Description	Length l1 – l0	Example
0	boolean_old	Logical value (false/true)	06	000000 is equivalent to false 111111 is equivalent to true
1	u_integer	Positive whole number	06	000000 to 999999
2	u_real	Fixed point number (unsigned)	06	001571 corresponds with 15.71
4	string	Any character string with 6 characters. ASCII codes between 32 and 127	06	TC_110, TM_700
6	boolean_new	Logical value (false/true)	01	0 is equivalent to false 1 is equivalent to true
7	u_short_int	Positive whole number	03	000 to 999
10	u_expo_new	Positive exponential number. The last of both digits are the exponent with a deduction of 20.	06	100023 is equivalent to $1,0 \cdot 10^3$ 100000 is equivalent to $1,0 \cdot 10^{-20}$
11	string16	Any character string with 16 characters. ASCII codes between 32 and 127	16	BrezelBier&Wurst
12	string8	Any character string with 8 characters. ASCII codes between 32 and 127	08	Example



## 6 Parameter set

### 6.1 General

Important settings and function-related characteristics are factory-programmed into the electronic drive unit as parameters. Each parameter has a three-digit number and a description. The parameter can be accessed via Pfeiffer Vacuum control units or externally via RS-485 using Pfeiffer Vacuum protocol.

The vacuum pump starts in standard mode with factory default pre-set parameters.



#### Non-volatile data storage

When switching off or in the event of unintentional voltage drop, the **parameters** and the operating hours stay saved in the electronics.









#	Three digit number of the parameter
Indicator	Display of parameter description
Description	Brief description of the parameters
Functions	Function description of the parameters
Data type	Type of formatting of the parameter for the use with the Pfeiffer Vacuum protocol
Access type	R (read): Read access; W (write): Write access
Unit	Physical unit of the described variable
min. / max.	Permissible limit values for the entry of a value
default	Factory default pre-setting (partially pump-specific)
	The parameter can be saved persistently in the electronic drive unit









Tbl. 8: Explanation and meaning of the parameters





### 6.2 Control commands

#	Display	Description	Functions	Data type	Access type	Unit	min.	max.	de- fault	
001	Heating	Heating	0 = off 1 = on	0	RW		0	1	0	✓
002	Stand-by	Stand-by	0 = off 1 = on	0	RW		0	1	0	✓
004	RUTimeCtrl	Run-up time monitoring	0 = off 1 = on	0	RW		0	1	1	✓
009	ErrorAckn	Malfunction acknowledgement	1 = Malfunction acknowledgement	0	W		1	1		
010	PumpgStatn	Pumping station	0 = off 1 = on and malfunction acknowledgement	0	RW		0	1	0	✓
012	EnableVent	Enable venting	0 = no 1 = yes	0	RW		0	1	0	✓
017	CfgSpdSwPt	Rotation speed switchpoint configuration	0 = Rotation speed switchpoint 1 1 = Rotation speed switchpoints 1 & 2	7	RW		0	1	0	✓

Parameter set



#	Display	Description	Functions	Data type	Access type	Unit	min.	max.	de- fault	
019	Cfg DO2	Output DO2 configuration	0 = Rotation speed switchpoint reached 1 = No error 2 = Error 3 = Warning 4 = Error and/or warning 5 = Set rotation speed reached 6 = Pump on 7 = Pump accelerating 8 = Pump decelerating 9 = Always "0" 10 = Always "1" 11 = Remote priority active 12 = Heating 13 = Backing pump 14 = Sealing gas 15 = Pumping station 16 = Pump rotating 17 = Pump has stopped 19 = Pressure switch point 1 not reached 20 = Pressure switch point 2 not reached 21 = Fore-vacuum valve, delayed 22 = Backing pump stand-by	7	RW		0	22	1	
023	MotorPump	Motor pump	0 = off 1 = on	0	RW		0	1	1	
024	Cfg DO1	Output DO1 configuration	Functions, see <b>[P:019]</b>	7	RW		0	22	0	
025	OpMode BKP	Backing pump operating mode	0 = continuous operation 1 = intermittent operation 2 = Delayed switching on 3 = Delayed interval operation	7	RW		0	3	0	
026	SpdSetMode	Rotation speed setting mode	0 = off 1 = on	7	RW		0	1	0	
027	GasMode	Gas mode	0 = heavy gases 1 = light gases 2 = Helium	7	RW		0	2	0	
030	VentMode	Venting mode	0 = delayed venting 1 = no venting 2 = direct venting	7	RW		0	2	2	

#	Display	Description	Functions	Data type	Access type	Unit	min.	max.	de-fault	
035	Cfg Acc A1	Configuration accessory connection A1	0 = fan (continuous operation) 1 = Venting valve, closed without current 2 = Heating 3 = Backing pump 4 = Fan (temperature controlled) 5 = Sealing gas 6 = Always "0" 7 = Always "1" 8 = Power failure venting unit 12 = Second venting valve 13 = No function	7	RW		0	13	0	
036	Cfg Acc B1	Configuration accessory connection B1	Functions, see <b>[P:035]</b>	7	RW		0	13	1	
041	Press1HVen	Release HV sensor integrated (only IKT)	0 = off 1 = on 2 = On, with rotation speed switch point reached 3 = On, with pressure switch point not reached	7	RW		0	3	2	
050	SealingGas	Sealing gas	0 = off 1 = on	0	RW		0	1	0	
055	Cfg AO1	Output AO1 configuration	0 = actual rotation speed 1 = output 2 = current 3 = Always 0 V 4 = Always 10 V 6 = Pressure value 1 7 = Pressure value 2 8 = Fore-vacuum control	7	RW		0	8	0	
058	TmpMgtMode	Temperature management configuration	0 = Pump housing temperature $\leq 60^\circ \text{C}$ 1 = Pump housing temperature $\leq 80^\circ \text{C}$ 2 = Power characteristic <b>[P:027]</b>	7	RW		0	2	0	
060	CtrlVialnt	Operate via interface	1 = remote 2 = RS-485 4 = PV.can 255 = Unlock interface selection	7	RW		1	255	1	
061	IntSelLckd	Interface selection locked	0 = off 1 = on	0	RW		0	1	0	

#	Display	Description	Functions	Data type	Access type	Unit	min.	max.	de-fault	
062	Cfg DI1	Input DI1 configuration	Setting # [P:063] 0 = Deactivated 1 = Enable venting 2 = Heating 3 = Sealing gas 4 = Run-up time monitoring 5 = Rotation speed setting mode 6 = Motor 7 = Enable HV sensor 1	7	RW		0	7	1	
063	Cfg DI2	Input DI2 configuration	Functions, see [P:062] Setting # [P:062]	7	RW		0	7	2	
068	Cfg Acc C1	Configuration accessory connection C1	Functions, see [P:035]	7	RW		0	13	0	
069	Cfg Acc D1	Configuration accessory connection D1	Functions, see [P:035]	7	RW		0	13	0	

Tbl. 9: Control commands

### 6.3 Status requests

#	Display	Description	Functions	Data type	Access type	Unit	min.	max.	de-fault	
300	RemotePrio	Remote priority	0 = no 1 = yes	0	R		0	1		
302	SpdSwPtAtt	Rotation speed switchpoint reached	0 = no 1 = yes	0	R		0	1		
303	Error code	Error code		4	R					
304	OvTempElec	Excess temperature drive electronics	0 = no 1 = yes	0	R		0	1		
305	OvTempPump	Excess temperature pump	0 = no 1 = yes	0	R		0	1		
306	SetSpdAtt	Set rotation speed reached	0 = no 1 = yes	0	R		0	1		
307	PumpAccel	Pump accelerating	0 = no 1 = yes	0	R		0	1		
308	SetRotSpd	Set rotation speed (Hz)		1	R	Hz	0	999999		
309	ActualSpd	Actual rotational speed (Hz)		1	R	Hz	0	999999		
310	DrvCurrent	Drive current		2	R	A	0	9999.99		
311	OpHrsPump	Pump operating hours		1	R	h	0	65535		
312	Fw version	Drive electronics software version		4	R					
313	DrvVoltage	Drive voltage		2	R	V	0	9999.99		
314	OpHrsElec	Drive electronics operating hours		1	R	h	0	65535		
315	Nominal Spd	Nominal rotation speed (Hz)		1	R	Hz	0	999999		
316	DrvPower	Drive power		1	R	W	0	999999		

#	Display	Description	Func-tions	Data type	Access type	Unit	min.	max.	de-fault	
319	PumpCycles	Pump cycles		1	R		0	65535		✓
324	TmpPwrStg	Temperature power stage		1	R	°C	0	999999		
326	TempElec	Electronics temperature		1	R	°C	0	999999		
330	TempPmpBot	Pump lower part temperature		1	R	°C	0	999999		
336	AccelDecel	Acceleration/deceleration		1	R	rpm/s	0	999999		
349	ElecName	Electronic drive unit designation		4	R					
354	HW Version	Hardware version drive electronics		4	R					
355	Serial No	Serial number		11	R					
360	ErrHist1	Error code history, item 1		4	R					✓
361	ErrHist2	Error code history, item 2		4	R					✓
362	ErrHist3	Error code history, item 3		4	R					✓
363	ErrHist4	Error code history, item 4		4	R					✓
364	ErrHist5	Error code history, item 5		4	R					✓
365	ErrHist6	Error code history, item 6		4	R					✓
366	ErrHist7	Error code history, item 7		4	R					✓
367	ErrHist8	Error code history, item 8		4	R					✓
368	ErrHist9	Error code history, item 9		4	R					✓
369	ErrHist10	Error code history, item 10		4	R					✓
384	TempRotor	Rotor temperature		1	R	°C	0	999999		
388	Order Code	Order number		11	R					
396	AddID	Pump ID		1	R					
397	SetRotSpd	Set rotation speed (rpm)		1	R	rpm	0	999999		
398	ActualSpd	Actual rotational speed (rpm)		1	R	rpm	0	999999		
399	NominalSpd	Nominal rotation speed (rpm)		1	R	rpm	0	999999		

Tbl. 10: Status requests

## 6.4 Reference value inputs

#	Display	Description	Func-tions	Data type	Access type	Unit	min.	max.	default	
700	RUTimeSVal	Set value run-up time		1	RW	min	1	120	8	✓
701	SpdSwPt1	Rotation speed switch point 1		1	RW	%	50	97	80	✓
707	SpdSVal	Set value in rotation speed setting mode		2	RW	%	20	100	65	✓
708	PwrSVal	Set value power consumption		7	RW	%	10	100	100 <sup>1)</sup>	✓
710	Swoff BKP	Backing pump switch-off threshold for intermittent operation		1	RW	W	0	1000	0	✓
711	SwOn BKP	Backing pump switch-on threshold for intermittent operation		1	RW	W	0	1000	0	✓

1) Depending on the pump type

#	Display	Description	Functions	Data type	Access type	Unit	min.	max.	default	
717	StdbySVal	Rotation speed set value in stand-by operation		2	RW	%	20	100	66.7	✓
719	SpdSwPt2	Rotation speed switch point 2		1	RW	%	5	97	20	✓
720	VentSpd	Venting at rotation speed, delayed venting		7	RW	%	40	98	50	✓
721	VentTime	Venting time, delayed venting		1	RW	s	6	3600	3600	✓
726	mxPwrOutTm	Max. time for the output voltage in power back-up mode		1	RW	s	1	255	10	✓
728	fanOnTemp	Start-up temperature of the fan in temperature-controlled mode		1	RW	°C	6	75	45	✓
730	PrsSwPt 1	Pressure switch point 1		10	RW	hPa			1000	✓
732	PrsSwPt 2	Pressure switch point 2		10	RW	hPa			1000	✓
733	PwrOutVolt	Output voltage in power back-up mode		2	RW	V	20.50	26.50	23.00	✓
734	PwrOutThrs	Power threshold from which the voltage is output from P733		1	RW	W	15	150	20	✓
739	PrsSn1Name	Name sensor 1		4	R					
740	Pressure 1	Pressure value 1		10	RW	hPa				✓
742	PrsCorrPi 1	Correction factor 1		2	RW		0.1	8.0	0	✓
749	PrsSn2Name	Name sensor 2		4	R					
750	Pressure 2	Pressure value 2		10	RW	hPa				✓
752	PrsCorrPi 2	Correction factor 2		2	RW		0.1	8.0	0	✓
777	NomSpdConf	Confirmation of nominal rotation speed		1	RW	Hz	0	1500	0	✓
797	RS485Adr	RS-485 Interface address		1	RW		1	255	1	✓

Tbl. 11: Reference value inputs

## 6.5 Additional parameters for the control unit



### Additional parameters in the control unit

The basic parameter set is set in the electronic drive unit ex-factory. For controlling connected external components (e.g. vacuum measuring equipment), additional parameters (extended parameter set) are available in the corresponding Pfeiffer Vacuum control units.

- Refer to the corresponding operating instructions of the respective components.
- Select the extended parameter set with parameter **[P:794] = 1**.

#	Indicator	Description	Functions	Data type	Access type	Unit	min.	max.	de- fault	
340	Pressure	Actual pressure value (ActiveLine)		7	R	hPa	$1 \cdot 10^{-10}$	$1 \cdot 10^3$		
350	Ctr Name	Control unit type		4	R					
351	Ctr Software	Control unit software version		4	R					
738	Gauge type	Type of pressure gauge		4	RW					

#	Indicator	Description	Functions	Data type	Access type	Unit	min.	max.	de- fault	
794	Param set	Parameter set	0 = Basic parameter set 1 = Extended parameter set	7	RW		0	1	0	
795	Servicelin	Insert service line		7	RW				795	

**Tbl. 12: Parameters for control unit functions**

## 7 Operation

### 7.1 Configuring the connections with the Pfeiffer Vacuum parameter set

The electronic drive unit is pre-configured with the factory default basic functions and is ready for operation. For individual requirements, you can configure most connections for the electronic drive unit with the parameter set.

#### 7.1.1 Configure digital inputs

Option	Description
0 = Deactivated	Connection not operational
1 = Enable vents	Control corresponds to parameter [P:012]
2 = Heating	Control corresponds to parameter [P:001]
3 = Sealing gas	Control corresponds to parameter [P:050]
4 = Run-up time control	Control corresponds to parameter [P:004]
5 = Rotation speed mode	Control corresponds to parameter [P:026]
6 = Motor	Control corresponds to parameter [P:023]
7 = Enable HV sensor	Control corresponds to parameter [P:041] (0 or 1 only)

Tbl. 13: Configure parameters [P:062] and [P:063]

#### 7.1.2 Configuring the digital outputs

Option	Description
0 = Rotation speed switchpoint reached	active, once the switch-point is reached
1 = No error	active, with trouble-free operation
2 = Error	active, if the error message is active
3 = Warning	active, if a warning message is active
4 = Error and/or warning	active, if an error and/or warning is active
5 = Set rotation speed reached	active, once the set rotation speed switch-point is reached
6 = Pump on	active, if pumping station on, motor on and no error
7 = Pump accelerating	active, if pumping station on, current rotation speed < set rotation speed
8 = Pump decelerating	active, if pumping station on, current rotation speed > set rotation speed Pumping station off, rotation speed > 3 Hz
9 = Always "0"	GND for the control of an external device
10 = Always "1"	+24 V DC for the control of an external device
11 = Remote priority active	active, if the remote priority is active
12 = Heating	Control corresponds to parameter [P:001]
13 = Backing pump	Control corresponds to parameters [P:010] and [P:025]
14 = Sealing gas	Control corresponds to parameter [P:050]
15 = Pumping station	Control corresponds to parameter [P:010]
16 = Pump rotating	active, if rotation speed > 1 Hz
17 = Pump has stopped	active, if rotation speed < 2 Hz
19 = Pressure switch point 1 not reached	Control corresponds to parameters [P:730] ([P:740] < [P:730])
20 = Pressure switch point 2 not reached	Control corresponds to parameters [P:732] ([P:750] < [P:732])



Option	Description
21 = Fore-vacuum valve, delayed	+24 V DC time-delayed after pumping station on
22 = Backing pump stand-by	Control of backing pump standby mode

Tbl. 14: Configure parameters [P:019] and [P:024]

### 7.1.3 Configure analog output

Option	Description	
0 = Rotational speed	Rotational speed signal; 0 - 10 V DC = 0 - 100% × $f_{\text{Nominal}}$	
1 = output:	Output signal; 0 - 10 V DC = 0 - 100% × $P_{\text{max}}$	
2 = current	Current signal; 0 - 10 V DC = 0 - 100% × $I_{\text{max}}$	
3 = Always 0 V	Always GND	
4 = Always 10 V	Permanent output 10 V DC	
6 = Pressure value 1	Pressure value signal; 0 V: Error 1 V: Undershot 1.5 - 8.5 V for sensor RPT p (hPa) = $10^{(U-5.5 \text{ V})}$ 1.5 - 8.5 V for sensor IKT p (hPa) = $10^{(U-10.5 \text{ V})}$ 9 V: Exceedence	
7 = Pressure value 2		
8 = Fore-vacuum control		Fore-vacuum side; Control of Pfeiffer Vacuum pumping stations

Tbl. 15: Configure parameter [P:055]

### 7.1.4 Configure accessory connections



#### Connect accessory devices to the TC 80

- Use of Pfeiffer Vacuum accessories via the electronic drive unit TC 80 is enabled via a corresponding connection cable or adapter at the "X3" multi-function connection.
- The desired accessory output is configured via RS-485 using Pfeiffer Vacuum display and control units or a PC.

#### Procedure

- Set the connections via parameter [P:035], [P:036], [P:068], or [P:069].

For parameters [P:068] and [P:069], the electronic drive unit automatically sets the option value if it detects an accessory at the turbopump connection.

Option	Description
0 = fan (continuous operation)	Control via pumping station parameters
1 = Venting valve, closed without current	Control via parameter Enable venting. When using a venting valve closed without current
2 = Heating	Control via heating and speed switch point reached parameters
3 = Backing pump	Control via parameter Pumping station and backing pump operating mode
4 = Fan (temperature controlled)	Control via parameter Pumping station and temperature threshold value
5 = Sealing gas	Control via parameter Pumping station and sealing gas
6 = Always "0"	GND for the control of an external device
7 = Always "1"	+24 V DC for the control of an external device
8 = Power failure venting unit	Control via parameter Enable venting. When using a power failure venting unit

Tbl. 16: Configure accessory connections

### 7.1.5 Select interfaces

The option "Control via Interface" serve the display of the interface currently active in the electronic drive unit. The communication interfaces thus automatically achieve control priority.

Option	Description
1 = remote	Operation via connection "remote"
2 = RS-485	Operation via connection "RS-485"
4 = PV.can	For service purposes only

Tbl. 17: Parameter [P:060]

Option	Description
0 = off	Interface selection via parameter [P:060]
1 = on	Interface selection locked

Tbl. 18: Parameter [P:061]

## 7.2 Operating modes

### 7.2.1 Gas type-dependent operation

**NOTICE**

**Turbopump destruction due to gases with too high molecular masses**

The pumping of gases with impermissible high molecular masses leads to the destruction of the turbopump.

- ▶ Make sure that the gas mode is set correctly by [P:027] in the electronic drive unit.
- ▶ Consult Pfeiffer Vacuum before you use gases with higher molecular masses (> 80).

High gas throughput and high rotation speed lead to strong friction heating of the rotor. To avoid overheating, power to rotation speed characteristics are implemented in the electronic drive unit. The power characteristic enables the operation of the turbopump at any rotation speed with the maximum permissible gas throughput without thermally overloading the turbopump. The maximum power consumption depends on the gas type. 3 characteristics are available for the parameterization in order to completely exhaust the turbopump's capacity for each gas type.

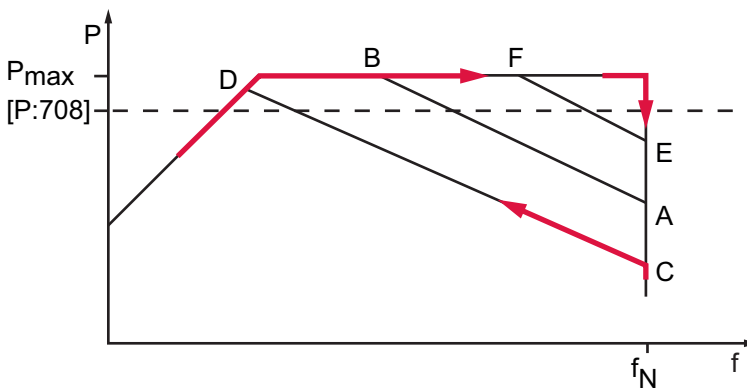

Fig. 8: Schematic diagram of power characteristics, example of heavy gases [P:027] = 0

- |                  |                           |     |   |
|------------------|---------------------------|-----|---|
| P                | Power consumption         | C-D | Power characteristic in gas mode "0" (gases with molecular mass > 39, e.g. Argon) |
| f                | Rotation speed            | A-B | Power characteristic in gas mode "1" (gases with molecular mass ≤ 39)             |
| P <sub>max</sub> | Maximum power consumption | E-F | Power characteristic in gas mode "2" (Helium)                                     |
| f <sub>N</sub>   | Nominal rotation speed    |     |   |

### Setting gas mode

1. Check the current gas mode set with parameter **[P:027]**.
2. Set the parameter **[P:027]** to the required value.
3. If necessary, set a lower frequency in rotation speed setting mode in order to avoid rotation speed fluctuations.

The turbopump runs up with maximum power consumption. When the nominal and/or set rotation speed is reached, the electronic drive unit automatically switches over to the chosen power characteristic of the selected gas mode. The increase in the power consumption initially compensates an increasing gas throughput to keep the rotation speed of the turbopump constant. The turbopump heats up higher due to the increasing gas friction. When the gas-type-dependent maximum power is exceeded, the rotation speed of the turbopump is reduced by the electronic drive unit until a permissible balance between power and gas friction is achieved.

## 7.2.2 Set value power consumption

### Set parameter **[P:708]**

When setting the specified power consumption below 100%, the run-up time is extended.

1. Set the parameter **[P:708]** to the required value in %.
2. Where necessary, adjust the parameter **[P:700] RUTimeSVal** to avoid error messages when starting up.

## 7.2.3 Run-up time

The turbopump run-up is time-monitored ex-factory. There are various causes of prolonged run-up times, for example:

- Excessive gas throughput
- Leak in system
- Setpoint of the run-up time too low

### Set parameter **[P:700]**

1. Where applicable, eliminate any external and application-related causes.
2. Adjust the run-up time with parameter **[P:700]**.

## 7.2.4 Rotation speed switch points

You can use the rotation speed switch point for the “turbopump operational for the process” message. Exceeding or underrunning the active rotation speed switch point activates or deactivates a signal at the pre-configured output on the electronic drive unit and at the status parameter **[P:302]**.

### Rotation speed switch point 1

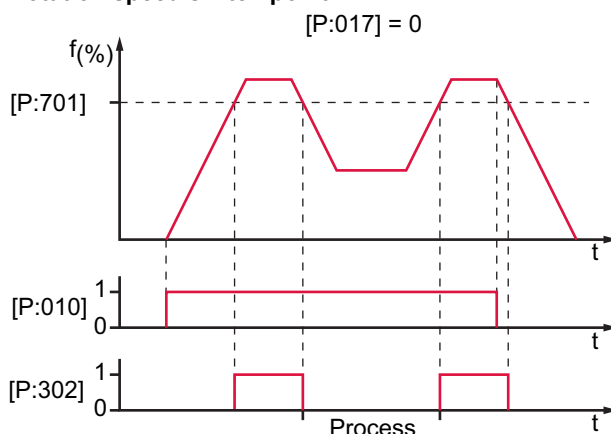

**Fig. 9: Rotation speed switch point 1 active**

### Adjusting rotation speed switch point 1

Signal output and status parameters are based on the set value for the rotation speed switch point 1 **[P:701]**.

1. Set the parameter **[P:701]** to the required value in %.
2. Set the parameter **[P:017]** to "0".

**Rotation speed switch points 1 & 2**

[P:017] = 1

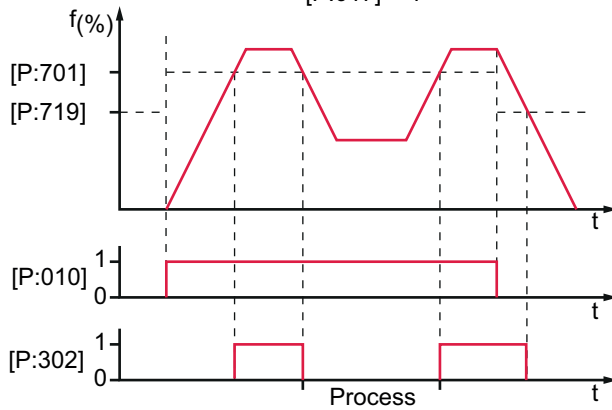

**Fig. 10:** Rotation speed switch points 1 & 2 active, [P:701] > [P:719]

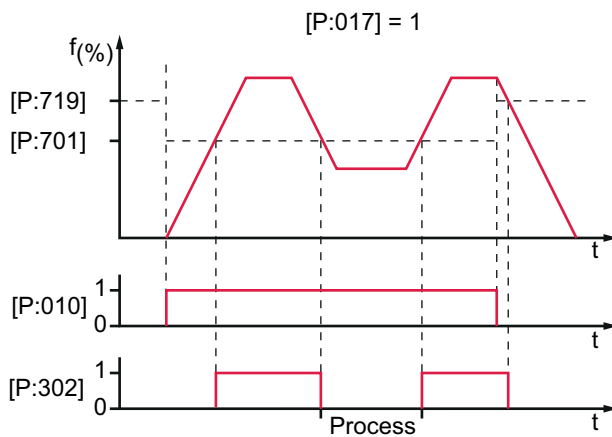

**Fig. 11:** Rotation speed switch points 1 & 2 active, [P:701] < [P:719]

**Setting the rotation speed switch points 1 & 2**

1. Set the parameter [P:701] to the required value in %.
2. Set the parameter [P:719] to the required value in %.
3. Set the parameter [P:017] to "1".

When the pumping station [P:010] is switched on, rotation speed switch point 1 is the signal generator. When the pumping station is switched off, the signal output and status request orientate at rotation speed switch point 2. The signal output is subject to the hysteresis between both switchpoints.

**7.2.5 Rotation speed setting mode**

The rotation speed setting mode reduces the speed and hence the pumping speed of the turbopump. The pumping speed of the turbopump changes proportional to its rotation speed. Standby mode is ineffective during rotation speed setting mode. The set value in rotation speed setting mode [P:707] sets the set rotation speed. The rotation speed switch point varies with the set rotation speed. Underrunning or exceeding the set value in rotation speed setting mode activates or deactivates the status signal [P:306] SetSpdAtt.



**Permissible variable rotation speed**

Values in the rotation speed setting mode or standby mode are subject to the permissible rotation speed range of the respective vacuum pump (technical data). Underrunning the minimum permissible value leads to the warning message **Wrn100**. The electronic drive unit automatically adjusts the set rotation speed to the next valid value.

**Set the rotation speed setting mode**

1. Set the parameter **[P:707]** to the required value in %.
2. Set the parameter **[P:026]** to "1".
3. Check the set rotation speed (parameter **[P:308]** or **[P:397]**).

**7.2.6 Standby**

Pfeiffer Vacuum recommends standby mode for the turbopump during process and production stops. When standby mode is active, the electronic drive unit reduces the rotation speed of the turbo pump. Standby mode is ineffective during rotation speed setting mode. The factory setting for stand-by mode is 66.7 % of the nominal rotation speed. Underrunning or exceeding the set value in standby mode activates or deactivates the status signal **[P:306] SetSpdAtt**.



**Permissible variable rotation speed**

Values in the rotation speed setting mode or standby mode are subject to the permissible rotation speed range of the respective vacuum pump (technical data). Underrunning the minimum permissible value leads to the warning message **Wrn100**. The electronic drive unit automatically adjusts the set rotation speed to the next valid value.

**Setting the related parameters**

1. Set the parameter **[P:717]** to the required value in %.
2. Set the parameter **[P:026]** to "0".
3. Set the parameter **[P:002]** to "1".
4. Check the set rotation speed (parameter **[P:308]** or **[P:397]**).

**7.2.7 Confirming the speed specification**

The typical nominal rotation speed of a turbopump is preset ex factory in the electronic drive unit. If the electronic drive unit is replaced or a different pump type is used, the set value settings of the nominal rotation speed is cleared. The manual confirmation of the nominal rotation speed is part of a redundant safety system as a measure for preventing excess rotation speed.

HiPace	Confirmation of nominal rotation speed <b>[P:777]</b>
HiPace 10 Neo	1500 Hz
HiPace 30 Neo	
HiPace 80 Neo	

**Tbl. 19: Characteristic nominal rotation speeds of the turbopumps**

**Required aids**

- A connected Pfeiffer Vacuum display and control unit.
- Knowledge of the configuration and setting of electronic drive unit operating parameters.

**Set parameter **[P:777]****

- ▶ Set the parameter **[P:777]** according to the pump type.

Once the nominal rotation speed is reached, the turbopump will run at idle without additional gas throughput. Depending on process or application requirements, the nominal rotation speed can be reduced in rotation speed setting mode or stand-by mode.

**7.2.8 Backing pump operating modes**

Operation of a connected backing pump via the electronic drive unit depends on the backing pump type.

Operating mode <b>[P:025]</b>	Recommended booster pump
"0" Continuous operation	All backing pumps
"1" Interval mode	Diaphragm pumps only
"2" Delayed switching on	All backing pumps
"3" Delayed interval mode	Diaphragm pumps only

**Tbl. 20: Backing pump operating modes**

### Setting continuous operation

With "pumping station on", the electronic drive unit sends a signal to the configured accessory connection to switch on the backing pump.

1. Set the parameter **[P:025]** to "0".
2. Use this signal for the control of a fore-vacuum safety valve.

### Set interval operation and determine the switching threshold

Interval operation extends the service life of the diaphragm of a connected diaphragm pump. Either a diaphragm pump with a built-in semiconductor relay or an interconnected relay box with a semiconductor relay is required for interval operation. The electronic drive unit switches the backing pump on or off depending on the power consumption of the turbopump. A relationship to the fore-vacuum pressure results from the power consumption. The backing pump operating mode offers adjustable switch-on and switch-off thresholds. Fluctuations in the power consumption of idling turbopumps and varying fore-vacuum pressures of the backing pumps require individual settings of the interval operation.

Pfeiffer Vacuum recommends interval operation between 5 and 10 hPa. A pressure gauge and a dosing valve are required to set the switching thresholds.

1. Set the parameter **[P:025]** to "1".
2. Switch on the vacuum system with the parameter **[P:010]** ("pumping station").
3. Wait for the run-up.
4. Allow the gas to run via the dosing valve and set the fore-vacuum pressure to 10 hPa.
5. Read the drive power at parameter **[P:316]** and note the value.
6. Set the switch-on threshold of the backing pump with parameter **[P:711]** to the determined drive power for a 10 hPa fore-vacuum pressure.
7. Reduce the fore-vacuum pressure to 5 hPa.
8. Read the drive power at parameter **[P:316]** and note the value.
9. Set the switch-off threshold of the backing pump with parameter **[P:710]** to the determined drive power for a 5 hPa fore-vacuum pressure.

### Delayed switching on

Simultaneous switching on of the backing pump and turbopump may cause undesired gas flow. To avoid this, depending on the process or application requirements, you can operate the backing pump with a delayed switch-on. The delayed switch-on depends on the rotation speed of the turbopump. The delayed switch-on has a fixed value of 360 rpm in the electronic drive unit.

- Switch-off threshold, parameter **[P:710]**
- Switch-on threshold, parameter **[P:711]**
- Delay 8 s.

1. Set the parameter **[P:025]** to "2".
2. Use this signal for the control of a fore-vacuum safety valve.

### Delayed interval operation

Fluctuations during the interval operation may lead to the underrunning or exceeding the switching thresholds. To avoid undesired switching of the backing pump you can operate the interval operation using a switching delay, depending on the process or application requirements. The delay is depending on a permanently uninterrupted exceedence or undershot of the specified switching threshold.

- Switch-off threshold, parameter **[P:710]**
- Switch-on threshold, parameter **[P:711]**
- Delay 8 s.

1. Set the parameter **[P:025]** to "3".
2. Use this signal for the control of a fore-vacuum safety valve.

## 7.2.9 Backing pump standby mode

In case you are using a Pfeiffer Vacuum backing pump with rotation speed control, this can be used in standby mode by configuring the digital output **[P:019]** or **[P:024]**. The power consumption of the turbopump has a direct influence on the rotation speed of the backing pump.

### Configuring the stand-by mode

1. Establish the connection of the backing pump using a suitable connecting cable.
2. Set parameter **[P:019]** or **[P:024]** to "22" (backing pump stand-by mode).
3. Find the respective standby rotation speed from the corresponding operating instructions of the backing pump.

## 7.2.10 Operation with accessories



### Installation and operation of accessories

Pfeiffer Vacuum offers a series of special, compatible accessories for its products.

- Information and ordering options for approved [accessories](#) you can find online.
- The following accessories are not included in the scope of delivery.

### Procedure

- ▶ Set the connections via parameter **[P:035]**, **[P:036]**, **[P:068]**, or **[P:069]**.

For parameters **[P:068]** and **[P:069]**, the electronic drive unit automatically sets the option value if it detects an accessory at the turbopump connection.

### Manually configuring the heating

Activation of the connected housing heater depends on the rotation speed switchpoint 1 (factory configuration  $80\% \times f_{nominal}$ ).

1. Set parameter **[P:035]**, **[P:036]**, **[P:068]** or **[P:069]** to "2" for heating.
2. Switch the heating on or off with parameter **[P:001]**.

### Manually configuring the fan

- ▶ Set parameter **[P:035]**, **[P:036]**, **[P:068]** or **[P:069]** to "0" for continuous fan operation.
- ▶ Set parameter **[P:035]**, **[P:036]**, **[P:068]** or **[P:069]** to "4" for temperature-controlled fan operation.
- ▶ Use parameter **[P:728]** to set the desired start-up temperature for temperature-controlled fan operation.
  - The fan switches off when the temperature is 5 °C lower than the set start-up temperature.

### Manually configuring the sealing gas valve

1. Set parameter **[P:035]**, **[P:036]**, **[P:068]** or **[P:069]** to "5" for sealing gas.
2. Using parameter **[P:050]**, switch a connected sealing gas valve on or off via the pre-configured output.

## 7.2.11 Venting modes

The function "pumping station" enables the venting mode of the turbopump after switching off. The signal output is carried out with a fixed delay.

### Selecting the venting mode

1. Set parameter **[P:012]** to "1".
2. Select the venting mode with parameter **[P:030]** (3 possible modes).

### Delayed venting

1. Configure the beginning and the time for the venting after "pumping station off" depending on the rotation speed of the turbopump.
2. Set parameter **[P:030]** to "0".
3. With parameter **[P:720]**, set the venting speed to the nominal rotation speed in %.
4. With parameter **[P:721]**, set the venting speed in s.

The venting valve opens for the set venting time. In case of a power failure, the venting starts when underrunning the set venting speed. The venting period depends on the residual energy delivered by the turning rotor. The venting process stops, when power is restored.

### No venting

In this operating mode, the venting is deactivated.

- ▶ Set parameter **[P:030]** to "1".

### Direct venting

Venting starts with a delay of 6 sec. after "pumping station off". When the pumping station function is switched back on, the venting valve closes automatically. After a power failure, the venting starts after falling below a fixed specified type-specific rotation speed. When power is restored, the venting process is continued.

- ▶ Set parameter **[P:030]** to "2".

### 7.3 Switching on the turbopump

The "pumping station" parameter [P:010] comprises Turbopump operation with control of all connected accessory devices (e.g. backing pump).

**Procedure**

After successfully completing the self-test, the electronic drive unit resets pending and corrected error messages. The turbopump starts and all connected accessory devices start operation according to their configuration.

1. Set the parameter [P:023] to "1".
  - The parameter [P:023] switches the motor of the turbopump on.
2. Set the parameter [P:010] to "1".
3. Install suitable touch protection during the configuration of the temperature management [P:058] = "1" if the vacuum pump is freely accessible.

### 7.4 Switching off the turbopump

**NOTICE**

**Damage to the vacuum pump and electronic drive unit due to improper disconnection of components**

Even after the power supply has been switched off, the vacuum pump continues to deliver electrical energy during its run-down period. If the vacuum pump and electronic drive unit are disconnected prematurely, there is the risk of body contact and consequently the destruction of electronic components.

- ▶ Never disconnect the vacuum pump and electronic drive unit from each other if power is still connected or if the rotor is running.
- ▶ Monitor the rotation speed via the parameters available in the electronic drive unit (e.g. [P:398]).
- ▶ Wait until the vacuum pump comes to a standstill (rotation speed  $f = 0$ ).

Original power supply packs (e.g., TPS 110) and connection cables with blocking diode are available for the voltage supply to the TC 80 electronic drive unit. The connection cable with blocking diode prevents power from being fed back into the power supply after the turbopump is switched off.

**Procedure**

The electronic drive unit switches off the turbopump and activates pre-set accessory options (e.g. venting ON, backing pump OFF).

1. Set the parameter [P:010] to "0".
2. Wait until the turbopump comes to a complete standstill.
3. Disconnect the power supply according to the operating instructions of the turbopump or the power supply pack.

**Disconnecting from the mains**

- ▶ Disconnect the power supply pack from the mains to disconnect the current supply completely.



**Unplugging the mains plug**











Unplugging the mains plug during operation while the turbopump is at complete standstill immediately de-energizes the power supply pack and the devices that are connected to it.

### 7.5 Operation monitoring

#### 7.5.1 Operating mode display via LED

LEDs on the electronic drive unit show the basic operating states of the vacuum pump. A differentiated error and warning display is only possible for operation with the Pfeiffer Vacuum control unit or a PC.



LED	Symbol	LED status	Display	Meaning
Green 		Off	—	Currentless
		On, flashing		"pumping station OFF", rotation speed $\leq 60$ rpm
		On, inverse flashing		"pumping station ON", set rotation speed not reached
		On, constant		"pumping station ON", set rotation speed reached
		On, flashing		"pumping station OFF", speed $> 60$ rpm
Yellow 		Off	—	No warning
		On, constant		Warning
Red 		Off	—	No error, no warning
		On, constant		Error, malfunction

Tbl. 21: Behavior and meaning of the LEDs on the electronic drive unit

## 7.5.2 Temperature monitoring

If threshold values are exceeded, output signals from temperature sensors bring the turbopump to a safe condition. Depending on the type, temperature thresholds for warning and error messages are immutably stored in the electronic drive unit. For information purposes, various status requests are set up in the parameter set.

- In order to avoid switching off the turbopump, the electronic drive unit already reduces the power consumption in case of exceeding the warning threshold for excess temperature.
  - Examples are an impermissible motor temperature, or impermissibly high housing temperature.
- Further reduction of drive power and thus decreasing speed can potentially lead to underrun the rotation speed switchpoint. The turbopump switches off.
- Exceeding the temperature threshold for error messages switches off the turbopump immediately.

## 8 Recycling and disposal

### **WARNING**

#### **Health hazard through poisoning from toxic contaminated components or devices**

Toxic process media result in contamination of devices or parts of them. During maintenance work, there is a risk to health from contact with these poisonous substances. Illegal disposal of toxic substances causes environmental damage.

- ▶ Take suitable safety precautions and prevent health hazards or environmental pollution by toxic process media.
- ▶ Decontaminate affected parts before carrying out maintenance work.
- ▶ Wear protective equipment.



#### **Environmental protection**

You **must** dispose of the product and its components in accordance with all applicable regulations for protecting people, the environment and nature.

- Help to reduce the wastage of natural resources.
- Prevent contamination.

### 8.1 General disposal information

Pfeiffer Vacuum products contain materials that you must recycle.

- ▶ Dispose of our products according to the following:
  - Iron
  - Aluminium
  - Copper
  - Synthetic
  - Electronic components
  - Oil and fat, solvent-free
- ▶ Observe the special precautionary measures when disposing of:
  - Fluoroelastomers (FKM)
  - Potentially contaminated components that come into contact with media

### 8.2 Dispose of electronic drive unit

Electronic components and their housings contain material that must be recycled.

- ▶ Dispose of electronic components in a safe manner according to locally applicable regulations.

## 9 Malfunctions

### 9.1 General

#### **WARNING**

##### **Risk of injury from parts moving after a power failure or troubleshooting**

The "pumping station" function of the electronic drive unit will remain active after a power failure or if errors occur that shut down the vacuum pump or the system. When power is restored or after acknowledging a fault, the vacuum pump runs up automatically. There is a risk of injury to fingers and hands if they enter the operating range of rotating parts.

- ▶ Always keep the mains connection freely accessible so you can disconnect it at any time.
- ▶ Remove present mating plugs or bridges from the electronic drive unit possibly before the mains power returns, as these can cause an automatic run-up.
- ▶ Switch the pump off using the "Pumping station" function (parameter **[P:010]**).

Malfunctions of turbopump and electronic drive unit always result in a warning or error messages. In both cases, you receive an error code that you can read out via the interfaces of the electronic drive unit. Generally, the LEDs on the electronic drive unit show the operating messages. If an error occurs, the turbo pump and connected devices switch off. The selected venting mode starts after a preset delay.

### 9.2 Error codes

Errors (\*\* Error E—— \*\*) always cause the connected peripheral devices to be switched off.

Warnings (\* Warning F —— \*) do not cause components to be switched off.

#### **Handling malfunction messages**

1. Read out error codes via Pfeiffer Vacuum control units or a PC.
2. Remove the cause of the malfunction.
3. Reset the malfunction message with parameter **[P:009]**.
  - Use preconfigured interfaces or screen tiles on Pfeiffer Vacuum control units.

Error code	Problem	Possible causes	Remedy
Err001	Excess rotation speed	<ul style="list-style-type: none"> <li>• Device defective</li> </ul>	<ul style="list-style-type: none"> <li>• Contact <a href="#">Pfeiffer Vacuum Service</a></li> <li>• Only acknowledge for rotational speed f = 0</li> </ul>
Err002	Excess voltage	<ul style="list-style-type: none"> <li>• Incorrect power supply pack</li> <li>• Incorrect mains input voltage</li> </ul>	<ul style="list-style-type: none"> <li>• Check the power supply pack type</li> <li>• Check the mains input voltage</li> <li>• Only acknowledge for rotational speed f = 0</li> </ul>
Err006	Run-up error	<ul style="list-style-type: none"> <li>• Run-up time threshold set too low</li> <li>• Gas flow in recipients through leaks or open valves</li> <li>• Still below speed-control switch point run-up time expires</li> </ul>	<ul style="list-style-type: none"> <li>• Adjust run-up time to process conditions</li> <li>• Check vacuum chambers for leaks and closed valves</li> <li>• Adjust rotation speed switch point</li> </ul>
Err007	Operating fluid low	<ul style="list-style-type: none"> <li>• Operating fluid low</li> </ul>	<ul style="list-style-type: none"> <li>• Check operating fluid</li> <li>• Only acknowledge for rotational speed f = 0</li> </ul>
Err008	Electronic drive unit - turbopump connection faulty	<ul style="list-style-type: none"> <li>• Connection to turbopump faulty</li> </ul>	<ul style="list-style-type: none"> <li>• Check the connections</li> <li>• Only acknowledge for rotational speed f = 0</li> </ul>
Err010	Internal device error	<ul style="list-style-type: none"> <li>• Device defective</li> </ul>	<ul style="list-style-type: none"> <li>• Contact <a href="#">Pfeiffer Vacuum Service</a></li> <li>• Only acknowledge for rotational speed f = 0</li> </ul>
Err021	Electronic drive unit does not detect turbopump	<ul style="list-style-type: none"> <li>• Incompatible software version</li> <li>• Device defective</li> </ul>	<ul style="list-style-type: none"> <li>• Contact <a href="#">Pfeiffer Vacuum Service</a></li> <li>• Only acknowledge for rotational speed f = 0</li> </ul>
Err041	Drive fault	<ul style="list-style-type: none"> <li>• Device defective</li> </ul>	<ul style="list-style-type: none"> <li>• Contact <a href="#">Pfeiffer Vacuum Service</a></li> <li>• Only acknowledge for rotational speed f = 0</li> </ul>

## Malfunctions

Error code	Problem	Possible causes	Remedy
Err043	Internal configuration error	<ul style="list-style-type: none"> <li>Device defective</li> </ul>	<ul style="list-style-type: none"> <li>Contact Pfeiffer Vacuum Service</li> </ul>
Err044	Excess temperature, electronics	<ul style="list-style-type: none"> <li>Insufficient cooling</li> </ul>	<ul style="list-style-type: none"> <li>Improve the cooling</li> <li>Check the operating conditions</li> </ul>
Err045	Excess temperature, motor	<ul style="list-style-type: none"> <li>Insufficient cooling</li> </ul>	<ul style="list-style-type: none"> <li>Improve the cooling</li> <li>Check the operating conditions</li> </ul>
Err046	Internal initialization error	<ul style="list-style-type: none"> <li>Device defective</li> </ul>	<ul style="list-style-type: none"> <li>Contact Pfeiffer Vacuum Service</li> </ul>
Err073	Axial magnetic bearing overload	<ul style="list-style-type: none"> <li>Rate of pressure rise too high</li> </ul>	<ul style="list-style-type: none"> <li>Check the operating conditions</li> <li>Only acknowledge for rotational speed <math>f = 0</math></li> </ul>
Err074	Radial magnetic bearing overload	<ul style="list-style-type: none"> <li>Rate of pressure rise too high</li> </ul>	<ul style="list-style-type: none"> <li>Check the operating conditions</li> <li>Only acknowledge for rotational speed <math>f = 0</math></li> </ul>
Err089	Rotor instable	<ul style="list-style-type: none"> <li>Impacts, vibrations</li> <li>Device defective</li> </ul>	<ul style="list-style-type: none"> <li>Check the operating conditions</li> <li>Contact Pfeiffer Vacuum Service</li> </ul>
Err091	Internal device error	<ul style="list-style-type: none"> <li>Device defective</li> </ul>	<ul style="list-style-type: none"> <li>Contact Pfeiffer Vacuum Service</li> </ul>
Err092	Unknown connection panel	<ul style="list-style-type: none"> <li>Device defective</li> </ul>	<ul style="list-style-type: none"> <li>Contact Pfeiffer Vacuum Service</li> </ul>
Err093	Motor temperature evaluation faulty	<ul style="list-style-type: none"> <li>Device defective</li> </ul>	<ul style="list-style-type: none"> <li>Contact Pfeiffer Vacuum Service</li> </ul>
Err094	Electronics temperature evaluation faulty	<ul style="list-style-type: none"> <li>Device defective</li> </ul>	<ul style="list-style-type: none"> <li>Contact Pfeiffer Vacuum Service</li> </ul>
Err098	Internal communication error	<ul style="list-style-type: none"> <li>External faults</li> <li>Device defective</li> </ul>	<ul style="list-style-type: none"> <li>Contact Pfeiffer Vacuum Service</li> <li>Only acknowledge for rotational speed <math>f = 0</math></li> </ul>
Err106	High rotor temperature	<ul style="list-style-type: none"> <li>High gas throughput</li> <li>Impermissible thermal radiation</li> <li>Impermissible magnetic field</li> </ul>	<ul style="list-style-type: none"> <li>Check the operating conditions</li> </ul>
Err107	Final stage group error	<ul style="list-style-type: none"> <li>External faults</li> <li>Device defective</li> </ul>	<ul style="list-style-type: none"> <li>Contact Pfeiffer Vacuum Service</li> <li>Only acknowledge for rotational speed <math>f = 0</math></li> </ul>
Err108	Rotation speed measurement faulty	<ul style="list-style-type: none"> <li>External faults</li> <li>Device defective</li> </ul>	<ul style="list-style-type: none"> <li>Contact Pfeiffer Vacuum Service</li> <li>Only acknowledge for rotational speed <math>f = 0</math></li> </ul>
Err109	Software not released	<ul style="list-style-type: none"> <li>Faulty software update</li> </ul>	<ul style="list-style-type: none"> <li>Contact Pfeiffer Vacuum Service</li> </ul>
Err110	Operating fluid evaluation faulty	<ul style="list-style-type: none"> <li>Operating fluid sensor faulty</li> </ul>	<ul style="list-style-type: none"> <li>Contact Pfeiffer Vacuum Service</li> <li>Only acknowledge for rotational speed <math>f = 0</math></li> </ul>
Err111	Operating fluid pump communication error	<ul style="list-style-type: none"> <li>External faults</li> <li>Device defective</li> </ul>	<ul style="list-style-type: none"> <li>Contact Pfeiffer Vacuum Service</li> <li>Only acknowledge for rotational speed <math>f = 0</math></li> </ul>
Err112	Operating fluid pump group error	<ul style="list-style-type: none"> <li>External faults</li> <li>Device defective</li> </ul>	<ul style="list-style-type: none"> <li>Contact Pfeiffer Vacuum Service</li> <li>Only acknowledge for rotational speed <math>f = 0</math></li> </ul>
Err113	Rotor temperature evaluation faulty	<ul style="list-style-type: none"> <li>Device defective</li> </ul>	<ul style="list-style-type: none"> <li>Contact Pfeiffer Vacuum Service</li> </ul>
Err114	Final stage temperature evaluation faulty	<ul style="list-style-type: none"> <li>Device defective</li> </ul>	<ul style="list-style-type: none"> <li>Contact Pfeiffer Vacuum Service</li> </ul>
Err117	Excess temperature, pump lower part	<ul style="list-style-type: none"> <li>Insufficient cooling</li> </ul>	<ul style="list-style-type: none"> <li>Improve the cooling</li> <li>Check the operating conditions</li> </ul>
Err118	Excess temperature, final stage	<ul style="list-style-type: none"> <li>Insufficient cooling</li> </ul>	<ul style="list-style-type: none"> <li>Improve the cooling</li> <li>Check the operating conditions</li> </ul>
Err119	Excess temperature, bearing	<ul style="list-style-type: none"> <li>Insufficient cooling</li> <li>Incorrect gas mode selected</li> <li>Insufficient sealing gas flow</li> </ul>	<ul style="list-style-type: none"> <li>Improve the cooling</li> <li>Check the operating conditions</li> </ul>
Err143	Operating fluid pump excess temperature	<ul style="list-style-type: none"> <li>Insufficient cooling</li> </ul>	<ul style="list-style-type: none"> <li>Improve the cooling</li> <li>Check the operating conditions</li> <li>Only acknowledge for rotational speed <math>f = 0</math></li> </ul>
Err777	Nominal rotation speed not confirmed	<ul style="list-style-type: none"> <li>Nominal rotation speed not confirmed after replacing the electronic drive unit</li> </ul>	<ul style="list-style-type: none"> <li>Confirm the nominal rotation speed with <b>[P:777]</b></li> <li>Only acknowledge for rotational speed <math>f = 0</math></li> </ul>

Error code	Problem	Possible causes	Remedy
Err800	Magnetic bearing overflow	<ul style="list-style-type: none"> <li>Impacts, vibrations</li> <li>Device defective</li> </ul>	<ul style="list-style-type: none"> <li>Contact Pfeiffer Vacuum Service</li> <li>Check the operating conditions</li> <li>Only acknowledge for rotational speed <math>f = 0</math></li> </ul>
Err802	Magnetic bearing sensor technology fault	<ul style="list-style-type: none"> <li>Calibration values invalid</li> <li>Device defective</li> </ul>	<ul style="list-style-type: none"> <li>Contact Pfeiffer Vacuum Service</li> <li>Perform a calibration procedure</li> <li>Only acknowledge for rotational speed <math>f = 0</math></li> </ul>
Err810	Internal configuration error	<ul style="list-style-type: none"> <li>Incompatible software version</li> </ul>	<ul style="list-style-type: none"> <li>Contact Pfeiffer Vacuum Service</li> <li>Only acknowledge for rotational speed <math>f = 0</math></li> </ul>
Err815	Magnetic bearing overflow	<ul style="list-style-type: none"> <li>Impacts, vibrations</li> <li>Device defective</li> </ul>	<ul style="list-style-type: none"> <li>Contact Pfeiffer Vacuum Service</li> <li>Check the operating conditions</li> <li>Only acknowledge for rotational speed <math>f = 0</math></li> </ul>
Err890	Safety bearing worn	<ul style="list-style-type: none"> <li>Safety bearing wear &gt; 100%</li> </ul>	<ul style="list-style-type: none"> <li>Contact Pfeiffer Vacuum Service</li> </ul>
Err891	Rotor imbalance too high	<ul style="list-style-type: none"> <li>Rotor imbalance &gt; 100%</li> </ul>	<ul style="list-style-type: none"> <li>Contact Pfeiffer Vacuum Service</li> <li>Only acknowledge for rotational speed <math>f = 0</math></li> </ul>

Tbl. 22: Error messages of the electronic drive unit

Error code	Problem	Possible causes	Remedy
Wrn001	TMS heat-up time expired	<ul style="list-style-type: none"> <li>Internal timer for heat-up monitoring exceeded</li> </ul>	<ul style="list-style-type: none"> <li>Check the operating conditions</li> <li>Check the mains input voltage</li> </ul>
Wrn003	TMS temperature invalid	<ul style="list-style-type: none"> <li>TMS temperature not in the permissible range between 5 °C and 85 °C</li> <li>TMS temperature sensor defective</li> </ul>	<ul style="list-style-type: none"> <li>Check the operating conditions</li> <li>Contact Pfeiffer Vacuum Service</li> </ul>
Wrn007	Undervoltage or power failure	<ul style="list-style-type: none"> <li>Mains failure</li> <li>Power supply pack dimensioned insufficiently</li> </ul>	<ul style="list-style-type: none"> <li>Check the power supply pack type</li> <li>Check the mains input voltage</li> </ul>
Wrn016	Accessory configuration invalid	<ul style="list-style-type: none"> <li>Impermissible configuration of the accessory outputs</li> </ul>	<ul style="list-style-type: none"> <li>Check the configuration of all accessory outputs</li> </ul>
Wrn018	Operating supremacy conflict	<ul style="list-style-type: none"> <li>Pumping station switched on with <b>[P:010]</b> while E74 input "start/stop" is off (opened)</li> </ul>	<ul style="list-style-type: none"> <li>Switch on the pumping station via E74 "start/stop"</li> <li>Switch <b>[P:010]</b> off</li> </ul>
Wrn021	Blocking signal invalid	<ul style="list-style-type: none"> <li>Signal of the blocking signal monitoring outside the valid range</li> </ul>	<ul style="list-style-type: none"> <li>Check the connections of the sealing gas monitoring</li> <li>Check the sealing gas supply</li> </ul>
Wrn034	Sealing gas flow too low	<ul style="list-style-type: none"> <li>Signal of the sealing gas monitoring valid but below the set threshold <b>[P:791]</b></li> </ul>	<ul style="list-style-type: none"> <li>Check and improve the sealing gas supply</li> </ul>
Wrn045	Motor high temperature	<ul style="list-style-type: none"> <li>Insufficient cooling</li> </ul>	<ul style="list-style-type: none"> <li>Improve the cooling</li> <li>Check the operating conditions</li> </ul>
Wrn076	Electronics high temperature	<ul style="list-style-type: none"> <li>Insufficient cooling</li> </ul>	<ul style="list-style-type: none"> <li>Improve the cooling</li> <li>Check the operating conditions</li> </ul>
Wrn089	Imbalance high	<ul style="list-style-type: none"> <li>Rotor imbalance</li> </ul>	<ul style="list-style-type: none"> <li>Contact Pfeiffer Vacuum Service</li> </ul>
Wrn097	Invalid pump information	<ul style="list-style-type: none"> <li>Internal communication error</li> </ul>	<ol style="list-style-type: none"> <li>Shut down pumping station</li> <li>Wait until the turbopump comes to a standstill</li> <li>Disconnect the power supply</li> <li>If this reoccurs, contact Pfeiffer Vacuum Service</li> </ol>
Wrn098	Incomplete pump information	<ul style="list-style-type: none"> <li>Internal communication error</li> </ul>	<ol style="list-style-type: none"> <li>Shut down pumping station</li> <li>Wait until the turbopump comes to a standstill</li> <li>Disconnect the power supply</li> <li>If this reoccurs, contact Pfeiffer Vacuum Service</li> </ol>
Wrn100	Minimum speed not reached	<ul style="list-style-type: none"> <li>Settings of the set rotation speed below the pump-specific minimum speed</li> </ul>	<ul style="list-style-type: none"> <li>Check <b>[P:707]</b> or <b>[P:717]</b></li> <li>Obtain the valid rotation speed range from the technical data of the turbopump</li> </ul>

Error code	Problem	Possible causes	Remedy
Wrn106	High rotor temperature	<ul style="list-style-type: none"> <li>High gas throughput</li> <li>Impermissible thermal radiation</li> <li>Impermissible magnetic field</li> </ul>	<ul style="list-style-type: none"> <li>Check the operating conditions</li> </ul>
Wrn113	Inaccurate rotor temperature	<ul style="list-style-type: none"> <li>Internal communication error</li> </ul>	<ul style="list-style-type: none"> <li>Contact Pfeiffer Vacuum Service</li> </ul>
Wrn115	Pump lower part temperature evaluation faulty	<ul style="list-style-type: none"> <li>Device defective</li> </ul>	<ul style="list-style-type: none"> <li>Contact Pfeiffer Vacuum Service</li> </ul>
Wrn116	Bearing temperature evaluation faulty	<ul style="list-style-type: none"> <li>Device defective</li> </ul>	<ul style="list-style-type: none"> <li>Contact Pfeiffer Vacuum Service</li> </ul>
Wrn117	Pump lower part high temperature	<ul style="list-style-type: none"> <li>Insufficient cooling</li> <li>Incorrect gas mode selected</li> </ul>	<ul style="list-style-type: none"> <li>Improve the cooling</li> <li>Check the operating conditions</li> </ul>
Wrn118	Final stage high temperature	<ul style="list-style-type: none"> <li>Insufficient cooling</li> <li>Incorrect gas mode selected</li> </ul>	<ul style="list-style-type: none"> <li>Improve the cooling</li> <li>Check the operating conditions</li> </ul>
Wrn119	Bearing high temperature	<ul style="list-style-type: none"> <li>Insufficient cooling</li> <li>Incorrect gas mode selected</li> <li>Insufficient sealing gas flow</li> </ul>	<ul style="list-style-type: none"> <li>Improve the cooling</li> <li>Check the operating conditions</li> </ul>
Wrn143	High operating fluid pump temperature	<ul style="list-style-type: none"> <li>Insufficient cooling</li> </ul>	<ul style="list-style-type: none"> <li>Improve the cooling</li> </ul>
Wrn168	High delay	<ul style="list-style-type: none"> <li>Rate of pressure rise too high</li> <li>Venting rate too high</li> </ul>	<ul style="list-style-type: none"> <li>Check the venting rate</li> <li>Adapt the venting rate to the pump</li> </ul>
Wrn801	Braking transistor defective	<ul style="list-style-type: none"> <li>Device defective</li> </ul>	<ul style="list-style-type: none"> <li>Contact Pfeiffer Vacuum Service</li> </ul>
Wrn806	Brake resistance defective	<ul style="list-style-type: none"> <li>Device defective</li> </ul>	<ul style="list-style-type: none"> <li>Contact Pfeiffer Vacuum Service</li> </ul>
Wrn807	Calibration requirement	<ul style="list-style-type: none"> <li>Calibration expired</li> </ul>	<ul style="list-style-type: none"> <li>Calibrate the turbopump by starting from standstill</li> </ul>
Wrn890	Safety bearing wear too high	<ul style="list-style-type: none"> <li>Safety bearing wear &gt; 75 %</li> </ul>	<ul style="list-style-type: none"> <li>Contact Pfeiffer Vacuum Service</li> </ul>
Wrn891	High rotor imbalance	<ul style="list-style-type: none"> <li>Rotor imbalance &gt; 75 %</li> </ul>	<ul style="list-style-type: none"> <li>Contact Pfeiffer Vacuum Service</li> </ul>

**Tbl. 23: Warning messages of the electronic drive unit**

### 9.3 Warning and malfunction messages when operating with control units

Besides the device-specific warning and error messages on the electronic drive unit, additional messages are displayed with the connected control unit.

Indicator	Problem	Possible causes	Remedy
* Warning F110 *	Pressure gauge	<ul style="list-style-type: none"> <li>Pressure gauge faulty</li> <li>Connection to the pressure gauge disconnected during operation</li> </ul>	<ul style="list-style-type: none"> <li>Check the cable connection</li> <li>Carry out a restart with pressure gauge connected</li> <li>Replace the pressure gauge completely</li> </ul>
** Error E040 **	Hardware error	<ul style="list-style-type: none"> <li>external RAM faulty</li> </ul>	<ul style="list-style-type: none"> <li>Contact Pfeiffer Vacuum Service</li> </ul>
** Error E042 **	Hardware error	<ul style="list-style-type: none"> <li>EPR0M checksum incorrect</li> </ul>	<ul style="list-style-type: none"> <li>Contact Pfeiffer Vacuum Service</li> </ul>
** Error E043 **	Hardware error	<ul style="list-style-type: none"> <li>E<sup>2</sup>PROM write error</li> </ul>	<ul style="list-style-type: none"> <li>Contact Pfeiffer Vacuum Service</li> </ul>
** Error E090 **	Internal device error	<ul style="list-style-type: none"> <li>RAM not large enough</li> <li>Unit is connected to incorrect electronic drive unit</li> </ul>	<ul style="list-style-type: none"> <li>Contact Pfeiffer Vacuum Service</li> <li>Connect the unit to the correct electronic drive unit</li> </ul>
** Error E698 **	Communication error	<ul style="list-style-type: none"> <li>Electronic drive unit is not responding</li> </ul>	<ul style="list-style-type: none"> <li>Contact Pfeiffer Vacuum Service</li> </ul>

**Tbl. 24: Warning and malfunction messages**

## 10 Service solutions by Pfeiffer Vacuum

### We offer first-class service

High vacuum component service life, in combination with low downtime, are clear expectations that you place on us. We meet your needs with efficient products and outstanding service.

We are always focused on perfecting our core competence – servicing of vacuum components. Once you have purchased a product from Pfeiffer Vacuum, our service is far from over. This is often exactly where service begins. Obviously, in proven Pfeiffer Vacuum quality.

Our professional sales and service employees are available to provide you with reliable assistance, worldwide. Pfeiffer Vacuum offers an entire range of services, from [original replacement parts](#) to [service contracts](#).

### Make use of Pfeiffer Vacuum service

Whether preventive, on-site service carried out by our field service, fast replacement with mint condition replacement products, or repair carried out in a [Service Center](#) near you – you have various options for maintaining your equipment availability. You can find more detailed information and addresses on our homepage, in the section.

**You can obtain advice on the optimal solution for you, from your [Pfeiffer Vacuum representative](#).**

**For fast and smooth service process handling, we recommend the following:**



1. Download the up-to-date form templates.
  - [Explanations of service requests](#)
  - [Service requests](#)
  - [Contamination declaration](#)



- a) Remove and store all accessories (all external parts, such as valves, protective screens, etc.).
  - b) If necessary, drain operating fluid/lubricant.
  - c) If necessary, drain coolant.
2. Complete the service request and contamination declaration.



3. Send the forms by email, fax, or post to your local [Service Center](#).



4. You will receive an acknowledgment from Pfeiffer Vacuum.

PFEIFFER VACUUM

### Submission of contaminated products

No microbiological, explosive, or radiologically contaminated products will be accepted. Where products are contaminated, or the contamination declaration is missing, Pfeiffer Vacuum will contact you before starting service work. Depending on the product and degree of pollution, **additional decontamination costs** may be incurred.

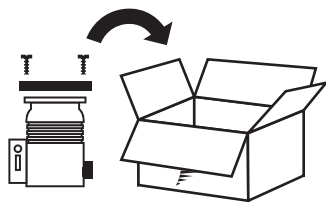

5. Prepare the product for transport in accordance with the provisions in the contamination declaration.
  - a) Neutralize the product with nitrogen or dry air.
  - b) Seal all openings with blind flanges, so that they are airtight.
  - c) Shrink-wrap the product in suitable protective foil.
  - d) Package the product in suitable, stable transport containers only.
  - e) Maintain applicable transport conditions.

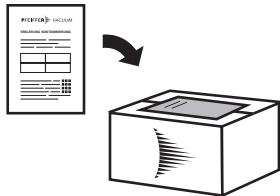

6. Attach the contamination declaration to the **outside** of the packaging.

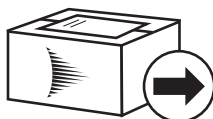

7. Now send your product to your local Service Center.

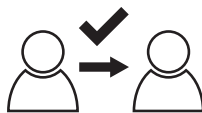

8. You will receive an acknowledgment/quotation, from Pfeiffer Vacuum.

PFEIFFER VACUUM

Our sales and delivery conditions and repair and maintenance conditions for vacuum devices and components apply to all service orders.



# EU Declaration of conformity

This declaration of conformity has been issued under the sole responsibility of the manufacturer.

Declaration for product(s) of the type:

## Electronic drive unit

TC 80

We hereby declare that the listed product satisfies all relevant provisions of the following **European Directives**.

### Low voltage 2014/35/EU

### Electromagnetic compatibility 2014/30/EU

### Restriction of the use of certain hazardous substances 2011/65/EU

### Restriction of the use of certain hazardous substances, delegated directive 2015/863/EU

### Harmonized standards and applied national standards and specifications:

DIN EN ISO 12100 : 2011

DIN EN 62061 : 2016

DIN EN 1012-2 : 2011

DIN ISO 21360-1 : 2016

DIN EN IEC 61000-3-2 : 2019

ISO 21360-4 : 2018

DIN EN 61000-3-3 : 2020

DIN EN IEC 63000 : 2019

DIN EN 61010-1 : 2020

Semi F47-0200

DIN EN 61326-1 : 2013

Semi S2-0706

Signature:



Pfeiffer Vacuum GmbH  
Berliner Straße 43  
35614 Asslar  
Germany

(Daniel Sälzer)  
Managing Director

Asslar, 2023-07-19



# UK Declaration of Conformity

This declaration of conformity has been issued under the sole responsibility of the manufacturer.

Declaration for product(s) of the type:

## Electronic drive unit

TC 80

We hereby declare that the listed product satisfies all relevant provisions of the following **British Directives**.

### Electrical Equipment (Safety) Regulations 2016

### Electromagnetic Compatibility Regulations 2016

### The Restriction of the Use of Certain Hazardous Substances in Electrical and Electronic Equipment Regulations 2012

#### Applied standards and specifications:

EN ISO 12100:2010	EN IEC 62061:2021
EN 1012-2+A1:1996	ISO 21360-1:2020
EN IEC 61000-3-2+A1:2019	ISO 21360-4:2018
EN 61000-3-3+A2:2013	IEC 63000:2018
EN 61010-1+A1:2017	Semi F47-0200
EN IEC 61326-1:2021	Semi S2-0706

The manufacturer's authorized representative in the United Kingdom and the authorized agent for compiling the technical documentation is Pfeiffer Vacuum Ltd, 16 Plover Close, Interchange Park, MK169PS Newport Pagnell.

Signature:



(Daniel Sälzer)  
Managing Director

Pfeiffer Vacuum GmbH  
Berliner Straße 43  
35614 Asslar  
Germany

Asslar, 2022-11-23

**UK  
CA**



## VACUUM SOLUTIONS FROM A SINGLE SOURCE

Pfeiffer Vacuum stands for innovative and custom vacuum solutions worldwide, technological perfection, competent advice and reliable service.

## COMPLETE RANGE OF PRODUCTS

From a single component to complex systems:

We are the only supplier of vacuum technology that provides a complete product portfolio.

## COMPETENCE IN THEORY AND PRACTICE

Benefit from our know-how and our portfolio of training opportunities!

We support you with your plant layout and provide first-class on-site service worldwide.

ed. D - Date 2404 - P/N:PT0659BEN



Are you looking for a  
perfect vacuum solution?  
Please contact us

Pfeiffer Vacuum GmbH  
Headquarters • Germany  
T +49 6441 802-0  
info@pfeiffer-vacuum.de

[www.pfeiffer-vacuum.com](http://www.pfeiffer-vacuum.com)

**PFEIFFER**  **VACUUM**